



# art&bath

**GENERAL CATALOG 2024**

CATALOGO GENERALE 2024





# NUMERICAL INDEX

INDICE NUMERICO

## KRION® **9**

AUSTIN	16
BALCA	18
HERMES	20
PERSEO	22
APOLO	23
HEROS	23
TIBET	24
SOJO	25
WILLIAM	26
QUARTER	27
SUTON	28
HARLEM	28
ROCK	29
JAZZ	29
SOUL	30
VULCANO	30
NEW	31
KRION® BOARDS	32
KRION® COMPLEMENTS	33

## SOLID SURFACE **35**

TRAVIS	38
ONIX	39
ARENA	40
MONACO	40
BOL	41
DIANA	41
BIEL	42
JUNO	42
ASTRA	43
ABRIL	43

## RESIN STONE **45**

HERA 1 SINK WITH SKIRT	46
HERA DOUBLE SINK WITH SKIRT	47
HERA DOUBLE SINK WITHOUT SKIRT	48
RESIN STONE BOARDS	49

## BATHTUBS **51**

MOAI	54
TERRY SOLID SURFACE	56
DEBA	58
DUERO	59
DANUBIO	60
LOIRA	61

## STONE **63**

AKUTAN	66
TOTEM	67
DAKOTA	68
GEA	69
TEXAS	69
ADWA	70
ABU	71
DANA	72
BERU	73
BELENUS	74
RACE	74
NAVIA	75
ARAMO	75
PETRA	76
DETROIT	77
ICON	78
EOS	79

## COUNTERTOP WASHBASINS **81**

VITO	84
FURNAS	86
EUROPE	88
DALLAS	88
ARA	89
TORMES	89
SIL	90
EUME	90
ONTARIO	91
QUEBEC	91
MÓNACO 48	92
MÓNACO 60	93
OBI	93
BOL CERAMIC	94
TEBAS	96
AURE	96
ROUND MINI	97
OVAL	97
LEO	98
SAJA	98
LIBRA	99
MENFIS	99
GEMINI 75	100
BEIRA	100
YELTES	101
ANUBIS	101
FOGO	102
CATAY	104
AMUR	105

IRIS	105
HORUS	106
OSIRIS	108
SATET	110
AJAX	112
AGNES	112
PIETRO	114
NOA	115

## WALL-HUNG WASHBASINS **117**

GORDON	120
PICOLO	121
LIBRA	121
SIL	122
EUME	122
GEMINI	123
LEO	123
ADONIA	124
DASHA	124
BEMUS	125

## DECORATIVE WASHBASINS **127**

TERRAZO	130
COPER	131
PRAGA	131
KARIBA	132
SFERA	132
DIPINTO	133
BELICE	133
ISEO	134
COMO	135
GÉNOVA	135
ORTA	136
GARDA	137
FIRENZE	137
GIZA	138
BOL BICOLOR	139
OSIRIS BICOLOR	139
NALON	140
BOL GOLD	141
BOL SILVER	141
BOL BRONZE	141
INDIANA	142
ACRIS	143
CUBE	143

## GALLERIA SERIES **145**

ANCORA	148
LAFONT	150

## CABINET BASIN **153**

ETNA MATTE	154
ETNA GLOSSY	154
ETNA NERO	158
QUADRA	159
THIN	160

## CABINETS AND ACCESSORIES **163**

SEVILLA	164
TOLEDO	164
LEG SET	164
HUESCA	165
SORIA	165
ÁVILA	165
VALVES	166
FIXING SUPPORTS	167
SIPHONS	168

# ALPHABETICAL INDEX

INDICE ALFABETICO

ABRIL	43	DETROIT	77	LEO WALL-HUNG	123	SUTON	28
ABU	71	DIANA	41	LIBRA	99	TEBAS	96
ACRIS	143	DIPINTO	133	LIBRA WALL-HUNG	121	TERRAZO	130
ADONIA	124	DUERO	59	LOIRA	61	TERRY SOLID SURFACE	56
ADWA	70	EOS	79	MENFIS	99	TEXAS	69
AGNES	112	ETNA GLOSSY	154	MOAI	54	THIN	160
AJAX	112	ETNA MATTE	154	MONACO	40	TIBET	24
AKUTAN	66	ETNA NERO	158	MÓNACO 48	92	TOLEDO	164
AMUR	105	EUME	90	MÓNACO 60	93	TORMES	89
ANCORA	148	EUME WALL-HUNG	122	NALON	140	TOTEM	67
ANUBIS	101	EUROPE	88	NAVIA	75	TRAVIS	38
APOLO	23	FIRENZE	137	NEW	31	VALVES	166
ARA	89	FIXING SUPPORTS	167	NOA	115	VITO	84
ARAMO	75	FOGO	102	OBI	93	VULCANO	30
ARENA	40	FURNAS	86	ONIX	39	WILLIAM	26
ASTRA	43	GARDA	137	ONTARIO	91	YELTES	101
AURE	96	GEA	69	ORTA	136		
AUSTIN	16	GEMINI	123	OSIRIS	108		
ÁVILA	165	GEMINI 75	100	OSIRIS BICOLOR	139		
BALCA	18	GÉNOVA	135	OVAL	97		
BEIRA	100	GIZA	138	PERSEO	22		
BELENUS	74	GORDON	120	PETRA	76		
BELICE	133	HARLEM	28	PICCOLO	121		
BEMUS	125	HERA 1 SINK WITH SKIRT	46	PIETRO	114		
BERU	73	HERA DOUBLE SINK WITHOUT SKIRT	48	PRAGA	131		
BIEL	42	HERA DOUBLE SINK WITH SKIRT	47	QUADRA	159		
BOL SOLID SURFACE	41	HERMES	20	QUARTER	27		
BOL BICOLOR	139	HEROS	23	QUEBEC	91		
BOL BRONZE	141	HORUS	106	RACE	74		
BOL CERAMIC	94	HUESCA	165	RESIN STONE BOARDS	49		
BOL GOLD	141	ICON	78	ROCK	29		
BOL SILVER	141	INDIANA	142	ROUND MINI	97		
CATAY	104	IRIS	105	SAJA	98		
COMO	135	ISEO	134	SATET	110		
COPER	131	JAZZ	29	SEVILLA	164		
CUBE	143	JUNO	42	SFERA	132		
DAKOTA	68	KARIBA	132	SIL	90		
DALLAS	88	KRION® BOARDS	32	SIL WALL-HUNG	122		
DANA	72	KRION® COMPLEMENTS	33	SIPHONS	168		
DANUBIO	60	LAFONT	150	SOJO	25		
DASHA	124	LEG SET	164	SORIA	165		
DEBA	58	LEO	98	SOUL	30		

WASHBASINS  
*LAVANDINI*

**KRION**  
ACRYLIC SOLID SURFACE

# WHAT IS KRION?

Krion® is a warm, compact material with a touch resembling natural stone. It is composed of two thirds of natural minerals (ATH: Alumina Trihydrate) and a low percentage of highly resistant resins.

This composition endows Krion® with clear, exclusive, high performance and versatility features. Krion® stands out for its lack of pores, in a refining process of 7 microns, which provides antibacterial capabilities without any additives, hardness, strength, durability, ease of repair, low maintenance and easy cleaning.

We can create joint-free spaces, which prevents the absorption of liquids and makes maintenance easier.

Krion® ECO-ACTIVE SOLID TECHNOLOGY is a revolutionary leap that Krion® has taken in the world of Solid Surface. This new Krion® technology is based on providing the material with a series of multiple properties, based on the natural phenomenon of photocatalysis.

It does not alter the original product at all, does not alter its physical qualities or color, has no limitations in use and is not a simple surface treatment. Of course, it does not contain any hazardous components.

This effect is active, meaning that every time sunlight strikes Krion®, this photocatalytic effect is reactivated, cleansing the surface of any bacteria or antigens.

# COS'È IL KRION?

*Il Krion® è un materiale caldo, compatto e con un tatto simile alla pietra naturale. Composto per due terzi da minerali naturali (ATH : Allumina triidrato) e una bassa percentuale di resine molto resistenti.*

*Questa composizione conferisce a Krion® caratteristiche chiare ed esclusive, oltre a prestazioni elevate e versatilità. Krion® si distingue per l'assenza di pori, in un processo di finitura di 7 micron, che gli conferisce proprietà antibatteriche senza alcun tipo di additivo, durezza, resistenza, durezza, facilità di riparazione, bassa manutenzione e facile pulizia.*

*Possiamo creare spazi senza giunzioni, che impediscono l'assorbimento di liquidi e facilitano la manutenzione.*

*Krion® ECO-ACTIVE SOLID TECHNOLOGY è un'innovazione rivoluzionaria che Krion® ha apportato al mondo del Solid Surface. Questa nuova tecnologia di Krion® consiste nel dotare il materiale di una serie di proprietà multiple, basate sul fenomeno naturale della fotocatalisi.*

*Non altera in alcun modo il prodotto originale, non ne altera le qualità fisiche né il colore, non ha limiti di utilizzo e non è un semplice trattamento superficiale. Ovviamente non contiene nessun componente pericoloso.*

*Questo effetto è attivo, il che significa che ogni volta che la luce solare incide su Krion®, questo effetto fotocatalitico si riattiva pulendo la superficie da qualsiasi batterio o antigene.*

**KRION®**  
PORCELANOSA Grupo





## ENDLESS POSSIBILITIES

The new generation Krion® mineral compact brings significant benefits to bathroom equipment and furniture.

Its high resistance to several factors, its warm touch, its non-porosity and, above all, its durability, are only some of the properties that stand out when developing Solid Surface bathrooms.

The ease of cleaning and repair of this material, together with its low maintenance, favor the development of solid surface bathroom fixtures that bring warmth and modernity to the space without neglecting utility.

## INFINITE POSSIBILITÀ

*Il minerale compatto Krion® di nuova generazione apporta notevoli miglioramenti alle attrezzature e ai mobili da bagno.*

*La sua alta resistenza a vari fattori, il suo calore al tatto, l'assenza di porosità e, soprattutto, la durata nel tempo, sono solo alcune delle proprietà che spiccano quando si tratta di sviluppare bagni di Solid Surface.*

*La facilità di pulizia e riparazione di questo materiale, nonché la sua facile manutenzione, favoriscono lo sviluppo di attrezzature per il bagno con superficie solida che apportano calore e modernità allo spazio senza trascurare l'utilità.*



## YOU SET THE LIMIT

Ask us whatever you need, you set the limit. If you can imagine it, you can do it. At Art & bath we want you to know that we can manufacture whatever you need, we are at your disposal for any of your projects.

The versatility that Krion® gives us has no limits. It is a potential that we want to explore with you. You design it and we manufacture it.

Don't just limit yourself to the bathroom. From kitchen countertops to desks, furniture or whatever you can think of.

We're here for you.

## IL LIMITE LO METTETE VOI

*Chiedeteci quello che vi serve, il limite lo mettete voi. Se si può immaginare, si può fare. Noi di Art & Bath desideriamo che sappiate che siamo in grado di produrre ciò di cui avete bisogno e siamo a vostra disposizione per tutti i vostri progetti.*

*La versatilità che offre Krion® non ha limiti. È un potenziale che desideriamo esplorare con voi. Voi lo progettate e noi lo produciamo.*

*Non limitatevi al bagno, dai top per cucina fino a scrivanie, a mobili o a qualsiasi altra cosa vi venga in mente.*

*Siamo a vostra disposizione.*



# HOW TO ORDER A CUSTOM-MADE KRION® WASHBASIN?

COME ORDINARE UN LAVANDINO DI KRION® PERSONALIZZATO?

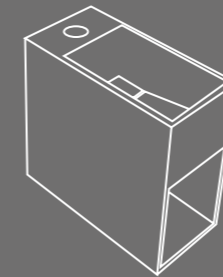

**1**

Choose the model, you can choose any washbasin from the Krion® family.

*Scegliete il modello, potete scegliere qualsiasi lavandino della famiglia Krion®.*



**2**

Choose your measurements, remember that they can be from the catalog or free choice, upon quotation. Select the dimensions of the sink and the countertop.

*Scegliete le vostre misure, ricordate che possono essere quelle del catalogo o a scelta libera, in base a preventivo. Selezionate le misure del seno e del piano di lavoro.*

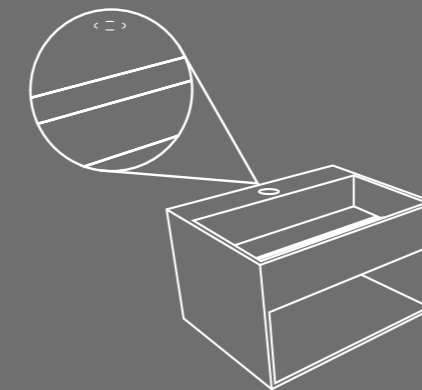

**3**

Let us know if you want it to have a faucet hole or not. This step is essential because by default it will never have a faucet hole.

*Diteci se volete che abbia un foro per il rubinetto o meno. Questo passaggio è molto importante perché, per difetto, non ce l'avrà mai.*

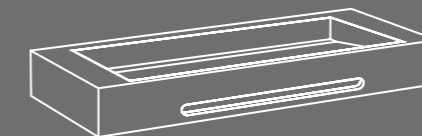

**4**

Add the accessories of your choice: skirting, overflow, skirt, die-cut towel rail...

*Aggiungete gli accessori che volete: battiscopa, sfioratore, pannello, portasciugamano, pre-tagliato...*





**CODING / CODIFICA**

DIMENSIONS MISURE	1 SINK 1 SENO	1 SINK + SKIRTING 1 SENO + PANNELLO
81x46	30.620.277	30.880.277
91x46	30.640.277	30.907.277
101x46	30.665.277	30.970.277
111x46	30.695.277	30.1077.277
121x46	30.755.277	30.1134.277
131x46	30.790.277	30.1169.277
141x46	30.830.277	30.1205.277
151x46	30.895.277	30.1230.277
161x46	30.935.277	30.1295.277
171x46	30.970.277	30.1354.277
181x46	30.1000.277	30.1460.277
191x46	30.1080.277	30.1550.277
201x46	30.1130.277	30.1650.277

**OPTIONS AND ACCESSORIES / OPZIONI E ACCESSORI**

Increase Sink 80	30.70.277
Incremento Seno 80	30.70.277
Increase Sink 100	30.110.277
Incremento Seno 100	30.110.277
Faucet machining	free of charge
Foro per il rubinetto	gratuito
Overflow	30.27.277
Sfioratore	30.27.277
Increase by enlargement of depth up to 53 cm.	15%
Supplemento per ampliamento fondo fino a 53 cm.	15%

Support structure (1 u)	30.24.277
Struttura supporto (1 un).	30.24.277
Front or side towel rail 32 - 42 cm	30.45.277
Portasciugamani frontale o laterale 32 - 42 cm	30.45.277
Skirting (5 cm) 30 € minimum	0,95€/cm lineare
Zoccolo (5 cm) 30 € min.	0,95€/cm lineare
Additional sink	30.275.277
Seno aggiuntivo	30.275.277

**TECHNICAL INFORMATION / INFORMAZIONI TECNICHE**

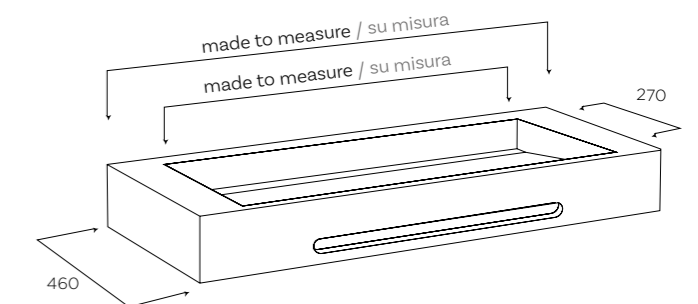
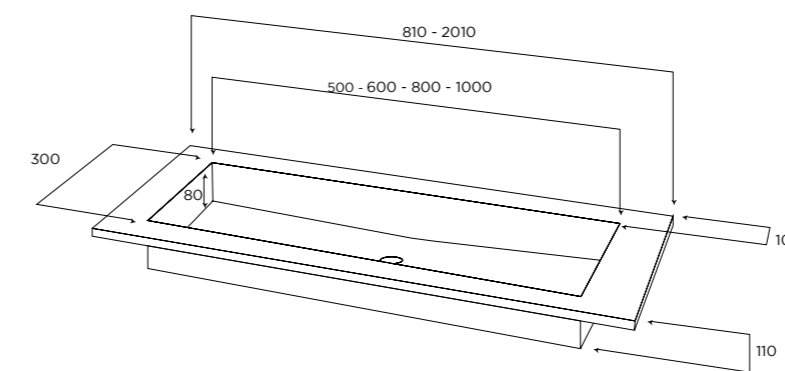

\* Unless otherwise indicated, no sink shall have a faucet hole.  
\* Salvo diversa indicazione, nessun lavandino avrà il foro per il rubinetto.



### CODING / CODIFICA

DIMENSIONS MISURE	1 SINK 1 SENO	1 SINK + SKIRTING 1 SENO + PANNELLO
81x46	30.753.277	30.972.277
91x46	30.768.277	30.1008.277
101x46	30.783.277	30.1042.277
111x46	30.798.277	30.1077.277
121x46	30.880.277	30.1134.277
131x46	30.890.277	30.1169.277
141x46	30.945.277	30.1250.277
151x46	30.1050.277	30.1325.277
161x46	30.1125.277	30.1425.277
171x46	30.1200.277	30.1520.277
181x46	30.1280.277	30.1595.277
191x46	30.1370.277	30.1725.277
201x46	30.1480.277	30.1860.277

### OPTIONS AND ACCESSORIES / OPZIONI E ACCESSORI

Increase by made to measure sink	15%
<i>Incremento per seno su misura</i>	15%
Faucet machining	free of charge
<i>Foro per il rubinetto</i>	gratuito
Overflow	30.27.277
<i>Sfioratore</i>	30.27.277
Increase by enlargement of depth up to 53 cm.	15%
<i>Supplemento per ampliamento fondo fino a 53 cm.</i>	15%

Support structure (1 u)	30.24.277
<i>Struttura supporto (1 un).</i>	30.24.277
Front or side towel rail 32 - 42 cm	30.45.277
<i>Portasciugamani frontale o laterale 32 - 42 cm</i>	30.45.277
Skirting (5 cm) 30 € minimum	0,95€/cm lineare
<i>Zoccolo (5 cm) 30 € min.</i>	0,95€/cm lineare
Additional sink	30.275.277
<i>Seno aggiuntivo</i>	30.275.277

### TECHNICAL INFORMATION / INFORMAZIONI TECNICHE

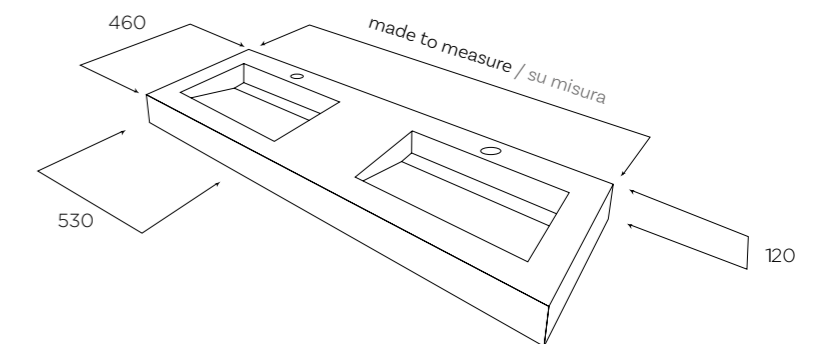
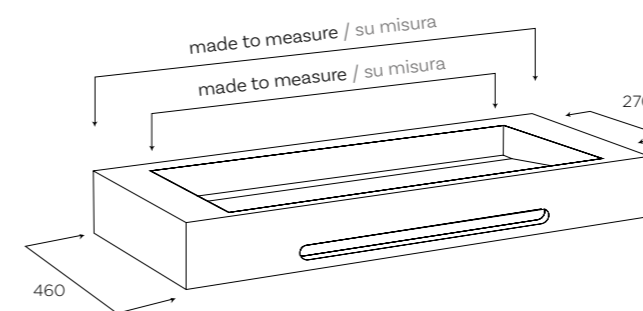

\* Unless otherwise indicated, no sink shall have a faucet hole.  
\* Salvo diversa indicazione, nessun lavandino avrà il foro per il rubinetto.



### CODING / CODIFICA

DIMENSIONS MISURE	1 SINK 1 SENO	1 SINK + SKIRTING 1 SENO + PANNELLO
61x46	30.343.277	30.545.277
71x46	30.362.277	30.583.277
81x46	30.385.277	30.628.277
91x46	30.407.277	30.675.277
101x46	30.430.277	30.720.277
111x46	30.453.277	30.766.277
121x46	30.476.277	30.812.277
131x46	30.551.277	30.917.277
141x46	30.574.277	30.964.277
151x46	30.597.277	30.1009.277
161x46	30.620.277	30.1055.277
171x46	30.644.277	30.1102.277
181x46	30.796.277	30.1294.277
191x46	30.826.277	30.1347.277
201x46	30.856.277	30.1402.277

### OPTIONS AND ACCESSORIES / OPZIONI E ACCESSORI

Faucet machining <i>Foro per il rubinetto</i>	free of charge <i>gratuito</i>	Support structure (1 u) <i>Struttura supporto (1 un).</i>	30.24.277
Overflow <i>Sfioratore</i>	30.27.277	Front or side towel rail 32 - 42 cm <i>Portasciugamani frontale o laterale 32 - 42 cm</i>	30.45.277
Additional sink <i>Seno aggiuntivo</i>	30.160.277	Skirting (5 cm) 30 € minimum <i>Zoccolo (5 cm) 30 € min.</i>	0,95€/cm lineare
Increase by enlargement of depth up to 53 cm. <i>Supplemento per ampliamento fondo fino a 53 cm.</i>	15%		0,95€/cm lineare

### TECHNICAL INFORMATION / INFORMAZIONI TECNICHE

**SINK S**  
400x270x100mm

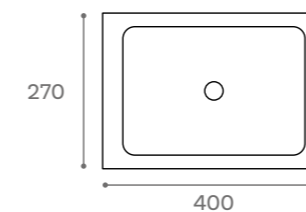

**SINK M**  
530x270x120mm

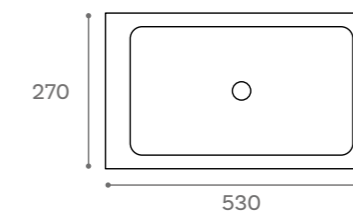

For sizes from 81 and double sinks from 141 included.  
*Per misure a partire da 81 e doppio seno a partire da 141 incluso.*

\* Unless otherwise indicated, no sink shall have a faucet hole.  
*\* Salvo diversa indicazione, nessun lavandino avrà il foro per il rubinetto.*

# PERSEO

WASHBASINS KRICN®



## OPTIONS AND ACCESSORIES / OPZIONI E ACCESSORI

Faucet machining <i>Foro per il rubinetto</i>	free of charge <i>gratuito</i>
Overflow <i>Sfiatore</i>	03.027.277
Additional sink <i>Seno aggiuntivo</i>	03.0160.277
Increase by enlargement of depth up to 53 cm. <i>Supplemento per ampliamento fondo fino a 53 cm.</i>	15%
Support structure (1 u) <i>Struttura supporto (1 un).</i>	03.024.277
Front or side towel rail 32 - 42 cm <i>Portasciugamani frontale o laterale 32 - 42 cm</i>	03.045.277
Zócalo (5 cm de altura.) 30 € mín. <i>Zoccolo (5 cm) 30 € mín.</i>	0,95€/cm linear 0,95€/cm lineare

## TECHNICAL INFORMATION / INFORMAZIONI TECNICHE

**SINK**  
100x270x90mm

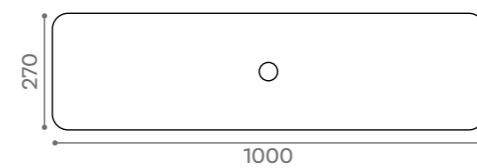

\* Unless otherwise indicated, no sink shall have a faucet hole.  
\* Salvo diversa indicazione, nessun lavandino avrà il foro per il rubinetto.

## CODING / CODIFICA

DIMENSIONS MISURE	1 SINK 1 SENO	1 SINK + SKIRTING 1 SENO + PANNELLO	DIMENSIONS MISURE	1 SINK 1 SENO	1 SINK + SKIRTING 1 SENO + PANNELLO
121x46	30.476.277	30.812.277	171x46	30.644.277	30.1102.277
131x46	30.551.277	30.917.277	181x46	30.796.277	30.1294.277
141x46	30.574.277	30.964.277	191x46	30.826.277	30.1347.277
151x46	30.597.277	30.1009.277	201x46	30.856.277	30.1402.277
161x46	30.620.277	30.1055.277			

# APOLO / HEROS

WASHBASINS KRICN®



## OPTIONS AND ACCESSORIES / OPZIONI E ACCESSORI

Faucet machining <i>Foro per il rubinetto</i>	free of charge <i>gratuito</i>
Overflow <i>Sfiatore</i>	03.027.277
Additional sink <i>Seno aggiuntivo</i>	03.0160.277
Increase by enlargement of depth up to 53 cm. <i>Supplemento per ampliamento fondo fino a 53 cm.</i>	15%
Support structure (1 u) <i>Struttura supporto (1 un).</i>	03.024.277
Front or side towel rail 32 - 42 cm <i>Portasciugamani frontale o laterale 32 - 42 cm</i>	03.045.277
Skirting (5 cm) 30 € minimum <i>Zoccolo (5 cm) 30 € mín.</i>	0,95€/cm linear 0,95€/cm lineare

## TECHNICAL INFORMATION / INFORMAZIONI TECNICHE

**SINK APOLO**  
500x300x80mm

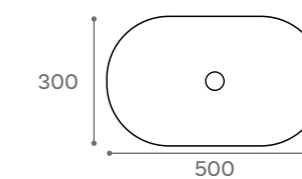

**SINK HEROS**  
370x370x80mm

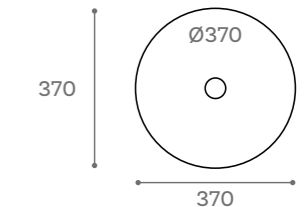

\* Unless otherwise indicated, no sink shall have a faucet hole.  
\* Salvo diversa indicazione, nessun lavandino avrà il foro per il rubinetto.

## CODING / CODIFICA

DIMENSIONS MISURE	1 SINK 1 SENO	1 SINK + SKIRTING 1 SENO + PANNELLO	DIMENSIONS MISURE	1 SINK 1 SENO	1 SINK + SKIRTING 1 SENO + PANNELLO
71x46	30.362.277	30.583.277	141x46	30.574.277	30.964.277
81x46	30.385.277	30.628.277	151x46	30.597.277	30.1009.277
91x46	30.407.277	30.675.277	161x46	30.620.277	30.1055.277
101x46	30.430.277	30.720.277	171x46	30.644.277	30.1102.277
111x46	30.453.277	30.766.277	181x46	30.796.277	30.1294.277
121x46	30.476.277	30.812.277	191x46	30.826.277	30.1347.277
131x46	30.551.277	30.917.277	201x46	30.856.277	30.1402.277



TECHNICAL INFORMATION / INFORMAZIONI TECNICHE

**CENTERED / CENTRATO**  
530X290mm SINK

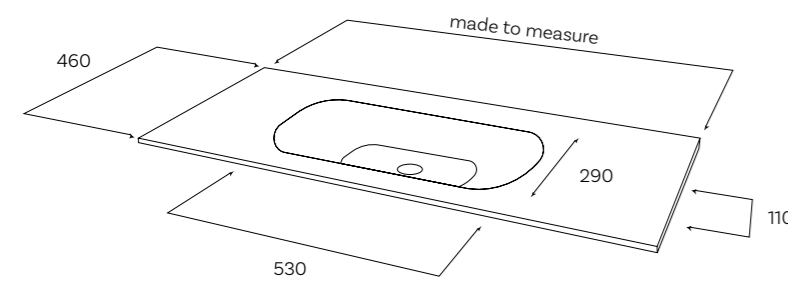

**OFFSET / SPOSTATO**  
450X290mm SINK

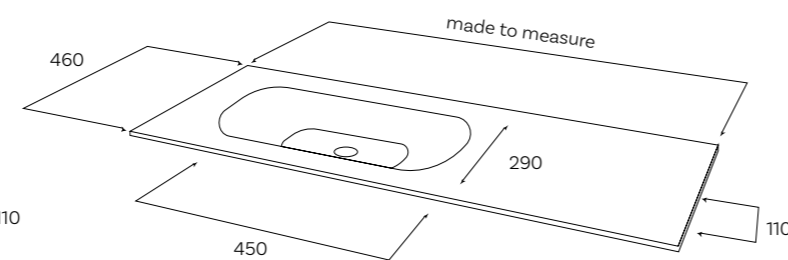

\* Product in stock, catalog and intermediate sizes will be served.  
\* Prodotto in stock, verranno fornite le misure del catalogo e quelle intermedie.

CODING / CODIFICA

DIMENSIONS MISURE	1 CENTERED SINK 1 SENO CENTRALE	1 OFFSET SINK 1 SENO SPOSTATO	DOUBLE SINK DOPPIO SENO
81x46	30.266.277	-	-
101x46	30.345.277	-	-
121x46	30.381.277	-	30.543.277
141x46	30.473.277	30.509.277	-
161x46	30.502.277	30.527.277	-



FEATURES / CARATTERISTICHE

Floor-standing washbasin.  
Available for built-in faucets and in two types of sinks at no additional cost; Austin and Balca.

*Lavandino con colonna.*  
*Disponibile per rubinetteria ad incasso e in due tipi di seno senza costi aggiuntivi: Austin e Balca.*

TECHNICAL INFORMATION / INFORMAZIONI TECNICHE

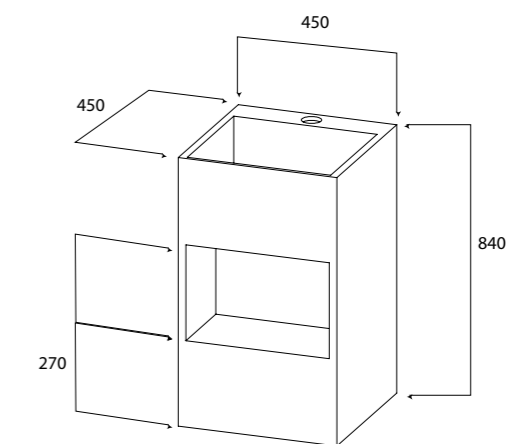

CODING / CODIFICA

MODEL MODELLO	CODE CODICE	REFERENCE RIFERIMENTO
SOJO K-LIFE WHITE	30.1478.277	LAV.SOJOKR

# WILLIAM

WASHBASINS KRION®



## FEATURES / CARATTERISTICHE

Suspended cabinet.  
With integrated washbasin.  
Fastening and screws included.  
Drawer with dampened closing.

*Mobile sospeso.  
Con lavandino integrato  
Fissaggio e viteria inclusi.  
Cassetto con chiusura ammortizzata.*

## TECHNICAL INFORMATION / INFORMAZIONI TECNICHE

### WILLIAM 100 CABINET

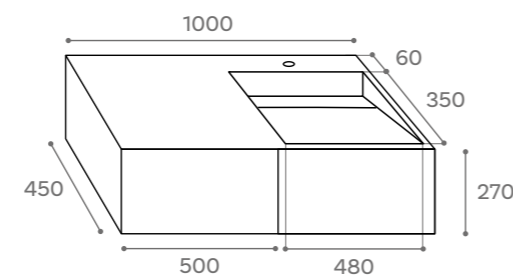

### WILLIAM 120 CABINET

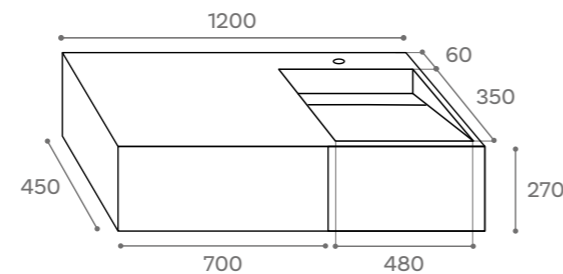

\* Unless otherwise indicated, no sink shall have a faucet hole.  
\* Salvo diversa indicazione, nessun lavandino avrà il foro per il rubinetto.

## CODING / CODIFICA

MODELLO	CODE CODICE	REFERENCE RIFERIMENTO
WILLIAM 100	30.1390.277	LAV.WILLIAM100
WILLIAM 120	30.1490.277	LAV.WILLIAM120

# QUARTER

WASHBASINS KRION®



## FEATURES / CARATTERISTICHE

Wall-hung washbasin.  
Fastening and screws included.

*Lavandino sospeso.  
Fissaggio e viteria inclusi.*

## TECHNICAL INFORMATION / INFORMAZIONI TECNICHE

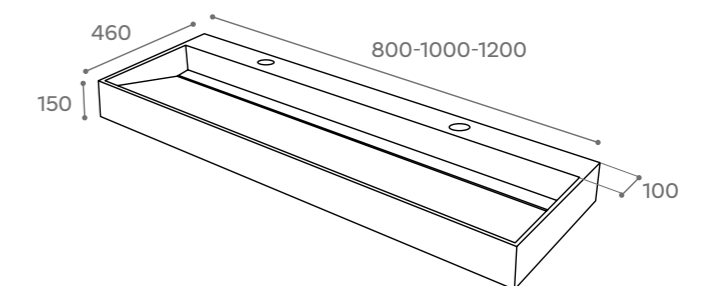

\* Unless otherwise indicated, no sink shall have a faucet hole.  
\* Salvo diversa indicazione, nessun lavandino avrà il foro per il rubinetto.

## CODING / CODIFICA

MODELLO	CODE CODICE	REFERENCE RIFERIMENTO
QUARTER 81X46	30.640.277	ESSIQ81X46
QUARTER 101X46	30.690.277	ESSIQ101X46
QUARTER 121X46	30.760.277	ESSIQ121X46

\*Available made to measure under previous quotation.  
\*Disponibile su misura con preventivo.

# SUTON

## WASHBASINSKRICN®



### FEATURES / CARATTERISTICHE

Wall-hung washbasin.  
No overflow.  
Fastening and screws  
included

Lavandino sospeso.  
Senza sfioratore.  
Fissaggio e viteria  
inclusi.

### TECHNICAL INFORMATION / INFORMAZIONI TECNICHE

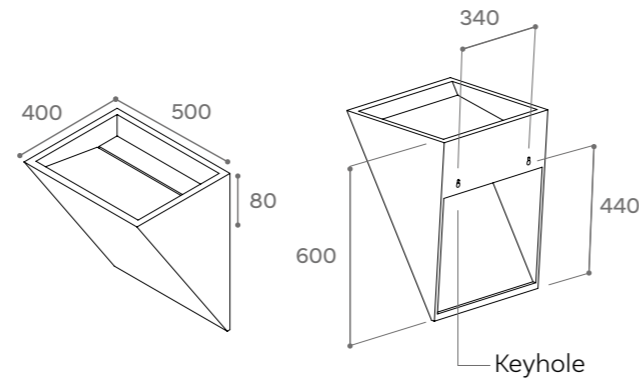

### CODING / CODIFICA

MODEL  
MODELLO  
SUTON

CODE  
CODICE  
30.736.277

REFERENCE  
RIFERIMENTO  
LAV.SUTONKR

# ROCK

## WASHBASINSKRICN®



### FEATURES / CARATTERISTICHE

Suspended cabinet.  
No overflow.  
Fastening and screws  
included

Mobile sospeso.  
Senza sfioratore.  
Fissaggio e viteria  
inclusi.

### TECHNICAL INFORMATION / INFORMAZIONI TECNICHE

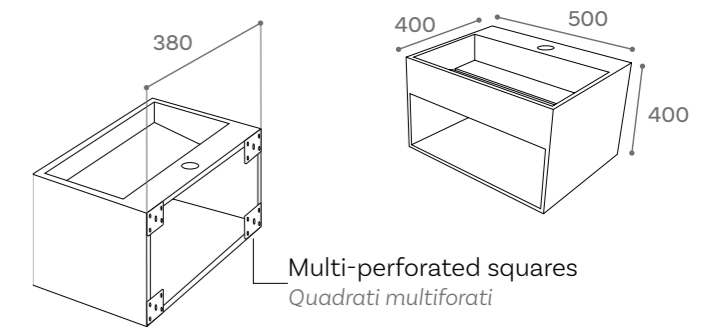

### CODING / CODIFICA

MODEL  
MODELLO  
ROCK

CODE  
CODICE  
30.969.277

REFERENCE  
RIFERIMENTO  
LAV.SOL.ROCK

\* Unless otherwise indicated, no sink shall have a faucet  
\* Salvo diversa indicazione, nessun lavandino avrà il foro per il rubinetto.

# HARLEM

## WASHBASINSKRICN®



### FEATURES / CARATTERISTICHE

Countertop washbasin  
No overflow.

Lavandino da appoggio.  
Senza sfioratore.

### TECHNICAL INFORMATION / INFORMAZIONI TECNICHE

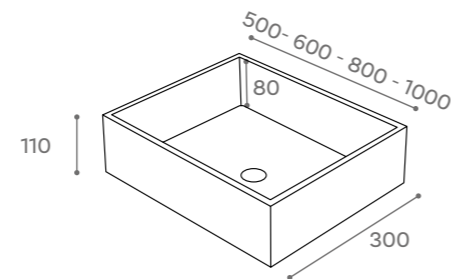

### CODING / CODIFICA

MODEL  
MODELLO  
HARLEM 50  
HARLEM 60  
HARLEM 80  
HARLEM 100

CODE  
CODICE  
30.436.277  
30.455.277  
30.490.277  
30.530.277

REFERENCE  
RIFERIMENTO  
LAV.HARLEM50  
LAV.HARLEM60  
LAV.HARLEM80  
LAV.HARLEM100

# JAZZ

## WASHBASINSKRICN®



### FEATURES / CARATTERISTICHE

Suspended cabinet.  
No overflow.  
Fastening and screws  
included

Mobile sospeso.  
Senza sfioratore.  
Fissaggio e viteria  
inclusi.

### TECHNICAL INFORMATION / INFORMAZIONI TECNICHE

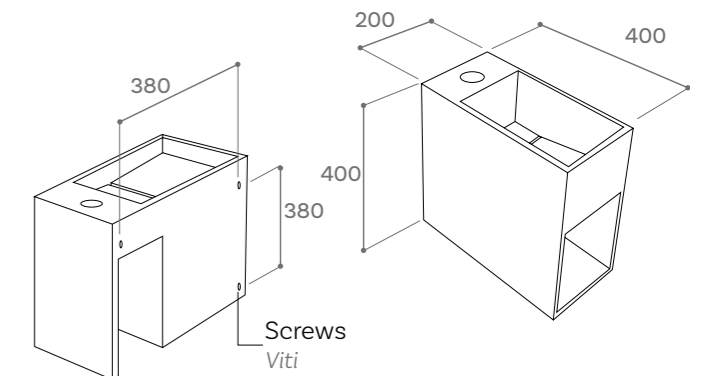

### CODING / CODIFICA

MODEL  
MODELLO  
JAZZ

CODE  
CODICE  
30.565.277

REFERENCE  
RIFERIMENTO  
MSSIJ

\* Unless otherwise indicated, no sink shall have a faucet  
\* Salvo diversa indicazione, nessun lavandino avrà il foro per il rubinetto.

# SOUL

WASHBASINSKRICH®



## FEATURES / CARATTERISTICHE

Suspended cabinet.  
No overflow.  
Fastening and screws  
included

*Mobile sospeso.  
Senza sfioratore.  
Fissaggio e viteria  
inclusi.*

## TECHNICAL INFORMATION / INFORMAZIONI TECNICHE

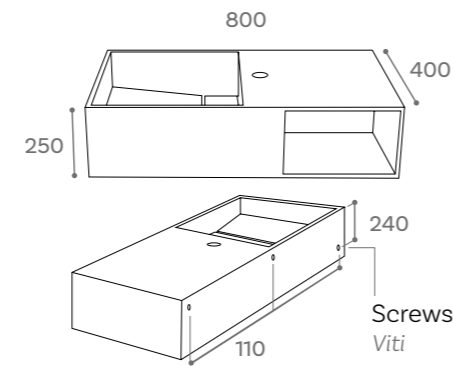

## CODING / CODIFICA

MODEL MODELLO	CODE CODICE	REFERENCE RIFERIMENTO
SOUL	30.1125.277	MSSIS

\* Unless otherwise indicated, no sink shall have a faucet  
\* Salvo diversa indicazione, nessun lavandino avrà il foro per il rubinetto.

# VULCANO

WASHBASINSKRICH®



## FEATURES / CARATTERISTICHE

Suspended cabinet.  
No overflow.  
Fastening and screws  
included

*Mobile sospeso.  
Senza sfioratore.  
Fissaggio e viteria  
inclusi.*

## TECHNICAL INFORMATION / INFORMAZIONI TECNICHE

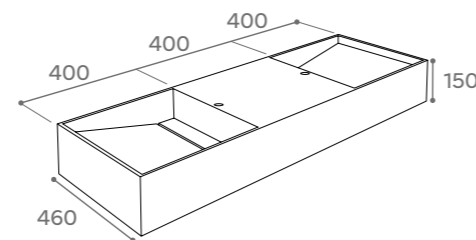

## CODING / CODIFICA

MODEL MODELLO	CODE CODICE	REFERENCE RIFERIMENTO
VULCANO	30.995.277	ESSIV121X46

\* Unless otherwise indicated, no sink shall have a faucet  
\* Salvo diversa indicazione, nessun lavandino avrà il foro per il rubinetto.

# NEW

WASHBASINSKRICH®



## FEATURES / CARATTERISTICHE

Wall-hung washbasin.  
Fastening and screws included.

*Lavandino sospeso.  
Fissaggio e viteria inclusi.*

## TECHNICAL INFORMATION / INFORMAZIONI TECNICHE

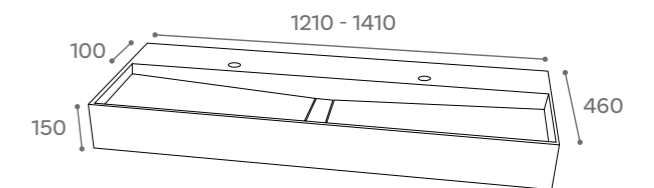

\* Unless otherwise indicated, no sink shall have a faucet hole.  
\* Salvo diversa indicazione, nessun lavandino avrà il foro per il rubinetto.

## CODING / CODIFICA

MODEL MODELLO	CODE CODICE	REFERENCE RIFERIMENTO
NEW 121X46	30.990.277	ESSIN121X46
NEW 141X46	30.1200.277	ESSIN141X46



# KRION® BOARDS

TAVOLE DI KRION®

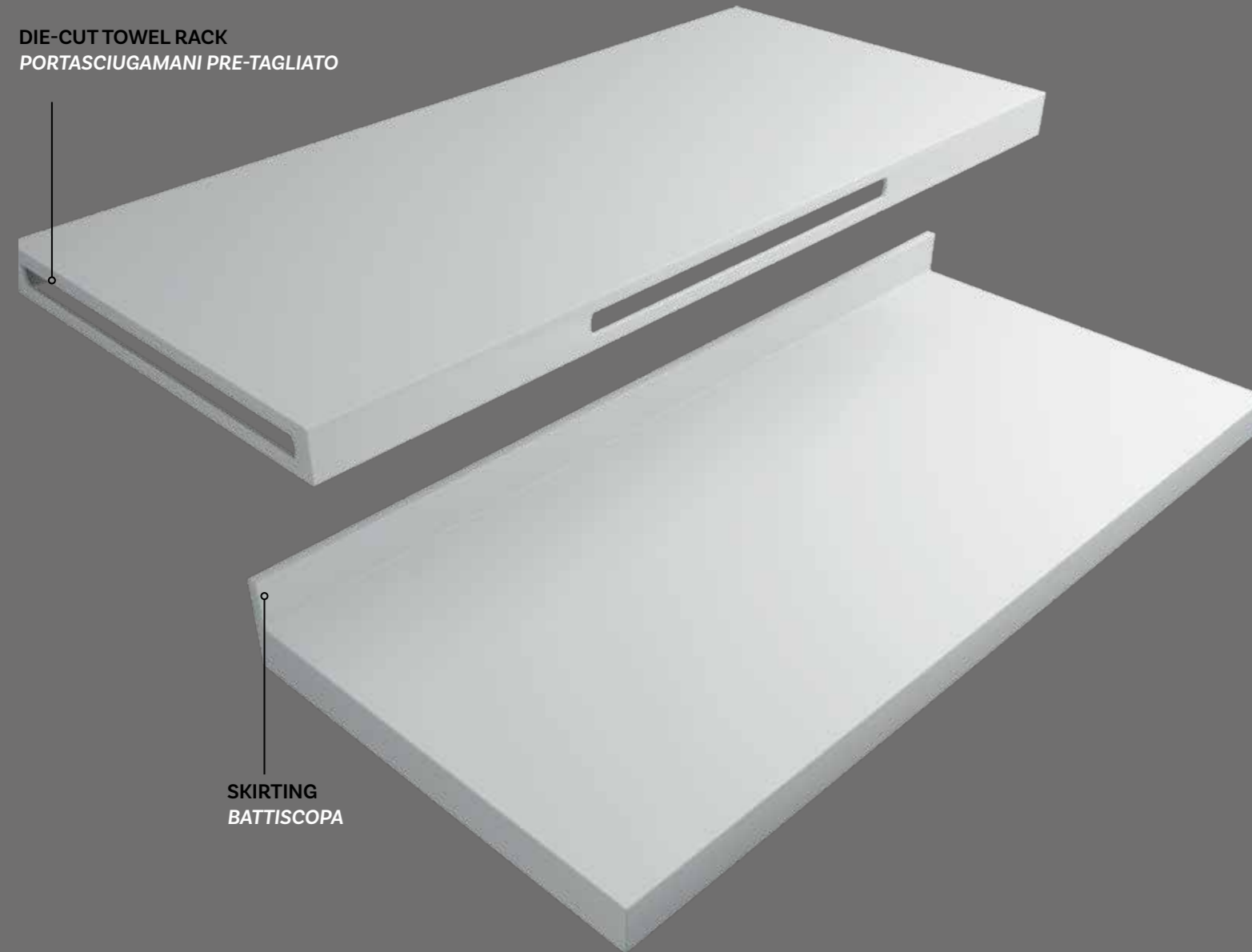

## CODING / CODIFICA

DIMENSIONS MISURE	BOARD TAVOLA	BOARD+SKIRT TAVOLA+PANNELLO
71x46	30.182.277	30.367.277
81x46	30.197.277	30.404.277
91x46	30.213.277	30.439.277
101x46	30.229.277	30.475.277
111x46	30.244.277	30.509.277
121x46	30.258.277	30.545.277
131x46	30.285.277	30.599.277
141x46	30.300.277	30.635.277
151x46	30.315.277	30.670.277
161x46	30.331.277	30.706.277
171x46	30.345.277	30.740.277
181x46	30.360.277	30.760.277
191x46	30.370.277	30.775.277
201x46	30.380.277	30.790.277

## ACCESSORIOS / ACCESSORI

Faucet and drain hole machining <i>Lavorazione foro rubinetto e scarico</i>	Free of charge <i>Gratuito</i>
Increase by enlargement of depth up to 53 cm. <i>Supplemento per ampliamento fondo fino a 53 cm.</i>	15%
Support structure (1 u) <i>Struttura supporto (1 un).</i>	30.24.277
Front or side towel rail 32 - 42 cm <i>Portasciugamani frontale o laterale 32 - 42 cm</i>	30.45.277
Skirting (5 cm) 30 € minimum <i>Zoccolo (5 cm) 30 € min.</i>	0,95€/cm linear 0,95€/cm lineare

# KRION® COMPLEMENTS

ACCESSORI DI KRION®

## PAPER ROLL HOLDER PORTAROTOLO

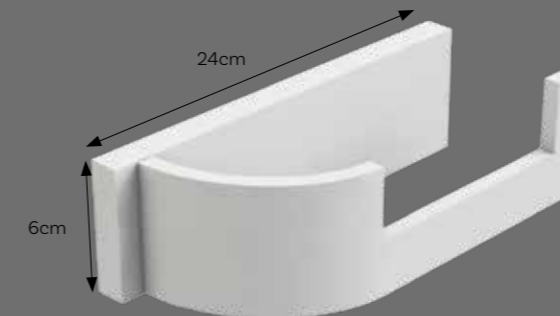

**CODE**  
**CODICE**  
30.59.277

**REFERENCE**  
**RIFERIMENTO**  
PTRLKR

## WASHBASIN TOWEL RAIL PORTASCIUGAMANI LAVANDINO

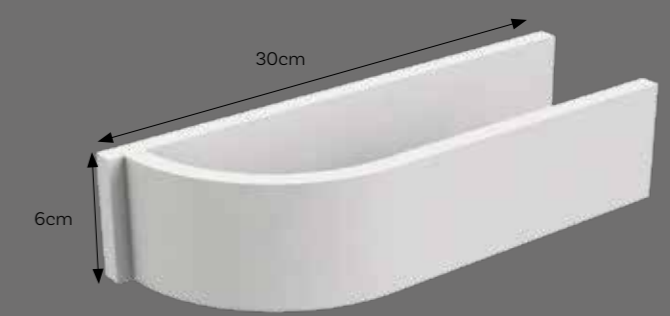

**CODE**  
**CODICE**  
30.49.277

**REFERENCE**  
**RIFERIMENTO**  
TOALGRKR

## BENCH SGABELLO

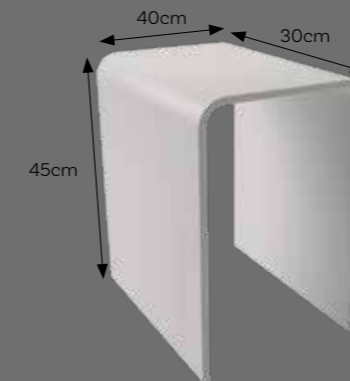

**CODE**  
**CODICE**  
30.160.277

**REFERENCE**  
**RIFERIMENTO**  
BAQTKR

## BIDET TOWEL RAIL PORTASCIUGAMANI BIDET

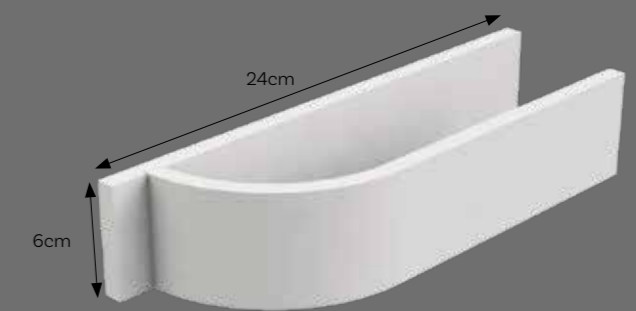

**CODE**  
**CODICE**  
30.42.277

**REFERENCE**  
**RIFERIMENTO**  
TOALPQKR

## SHOWER HANGER GANCIO DOCCIA

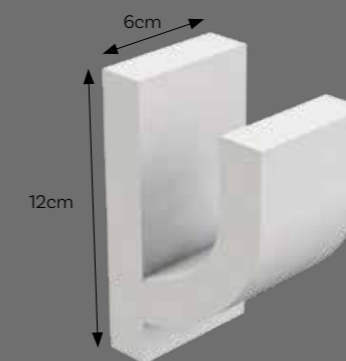

**CODE**  
**CODICE**  
30.32.277

**REFERENCE**  
**RIFERIMENTO**  
PERCHKR

## VALVE VALVOLA



**CODE**  
**CODICE**  
30.58.277

**REFERENCE**  
**RIFERIMENTO**  
VALUNI.TSI



WASHBASINS

LAVANDINI

**SOLID SURFACE**

## SOLID SURFACE WASHBASINS

Solid Surface stands as a state-of-the-art material in interior design, composed of polyester resins and an extremely fine ATH mineral. This combination of high quality raw materials guarantees a final product of great whiteness and durability. The fully automated, vacuum-mixed production processes ensure good compaction and uniformity in each piece.

The benefits of Solid Surface are remarkable, especially when it comes to the manufacture of custom-made washbasins. It is highly resistant to impact and daily wear and tear, while retaining its structural and aesthetic integrity over time. Its closed, non-porous surface not only makes it easy to clean on a daily basis, but is also aseptic and stain resistant. This material has anti-scratch and anti-slip properties, providing safety and preserving its original appearance.

Furthermore, Solid Surface stands out for its easy maintenance, reduced to cleaning with soapy water or creamy detergents. Its exceptional durability, repairability and the ability to produce custom washbasins make it a versatile and affordable choice for a variety of interior design applications. In short, Solid Surface offers attractive aesthetics combined with strength, ease of care and adaptability for the creation of custom washbasins that meet the specific needs of each project.

## LAVANDINI IN SOLID SURFACE

*Solid Surface si posiziona come un materiale all'avanguardia nell'interior design, composto da resine poliestere e da un minerale ATH estremamente sottile. Questa combinazione di materie prime di alta qualità garantisce un prodotto finale di grande bianchezza e durezza. I processi di produzione completamente automatizzati e con miscelazione sotto vuoto garantiscono una buona compattezza e uniformità in ogni pezzo.*

*I vantaggi del Solid Surface sono notevoli, soprattutto per quanto riguarda la produzione di lavandini su misura. Ha un'elevata resistenza agli urti e all'usura quotidiana e mantiene l'integrità strutturale ed estetica nel tempo. La sua superficie sigillata e priva di pori non solo facilita la pulizia quotidiana, ma è anche asettica e resistente alle macchie. Questo materiale offre proprietà antigraffio e antiscivolo, garantendo la sicurezza e la conservazione dell'aspetto originale.*

*Inoltre, il Solid Surface si distingue per la sua facile manutenzione, che può ridursi alla pulizia con acqua saponata o con detergenti cremosi. La sua durezza eccezionale, la riparabilità e la possibilità di realizzare lavandini su misura lo rendono una scelta versatile e accessibile per varie applicazioni nell'interior design. In sintesi, il Solid Surface offre un'estetica accattivante, abbinata a resistenza, facilità di manutenzione e adattabilità per creare lavandini personalizzati che soddisfino le esigenze specifiche di ogni progetto.*

# TRAVIS

## SOLID SURFACE WASHBASINS



### FEATURES CARATTERISTICHE

Floor-standing washbasin.  
No overflow.  
Product with no installation holes.  
Please ask for them expressly  
in case of need.

*Lavabo con colonna.  
Senza sfioratore.  
Prodotto senza fori di installazione.  
Richiedeteli espressamente in caso di  
necessità*

### FINISHING FINITURA

○ Matte white  
Bianco opaco

### TECHNICAL INFORMATION INFORMAZIONI TECNICHE

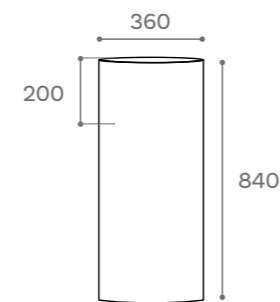
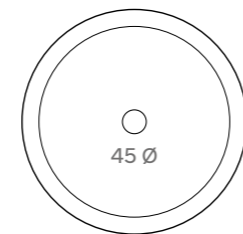

### CODING CODIFICA

MODEL MODELLO	CODE CODICE	REFERENCE RIFERIMENTO
TRAVIS	30.880.277	LAV.TRAVIS

# ONIX

## SOLID SURFACE WASHBASINS



### FEATURES CARATTERISTICHE

Floor-standing washbasin.  
With overflow.  
Product with no installation holes.  
Please ask for them expressly  
in case of need.

*Lavabo con colonna.  
Con sfioratore.  
Prodotto senza fori di installazione.  
Richiedeteli espressamente in caso di  
necessità*

### FINISHING FINITURA

○ Matte white  
Bianco opaco

### TECHNICAL INFORMATION INFORMAZIONI TECNICHE

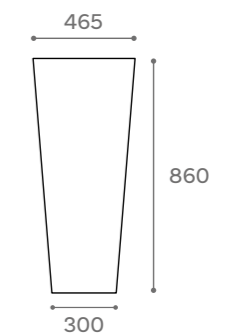
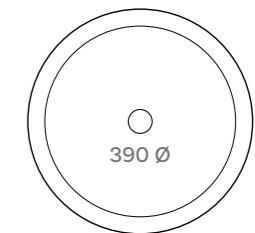

### CODING CODIFICA

MODEL MODELLO	CODE CODICE	REFERENCE RIFERIMENTO
ONIX	30.899.277	LSSONX

# ARENA

## SOLID SURFACE WASHBASINS



### FEATURES / CARATTERISTICHE

Countertop washbasin  
No overflow. *Lavandino da appoggio.  
Senza sfioratore.*

Matte white  
Bianco opaco

### TECHNICAL INFORMATION / INFORMAZIONI TECNICHE

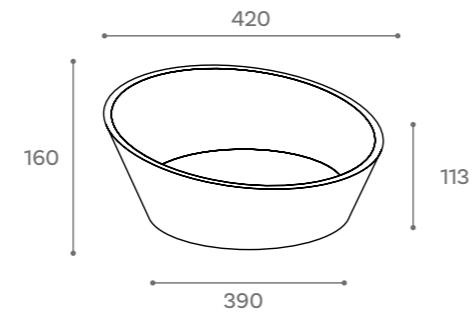

### CODING / CODIFICA

MODEL MODELLO	CODE CODICE	REFERENCE RIFERIMENTO
ARENA SOLID	30.270.277	LAV.SOL.ARENA

# BOL

## SOLID SURFACE WASHBASINS



### FEATURES / CARATTERISTICHE

Countertop washbasin  
No overflow. *Lavandino da appoggio.  
Senza sfioratore.*

Matte white  
Bianco opaco

### TECHNICAL INFORMATION / INFORMAZIONI TECNICHE

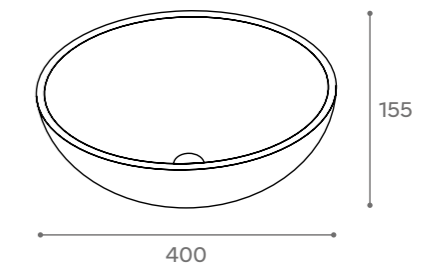

### CODING / CODIFICA

MODEL MODELLO	CODE CODICE	REFERENCE RIFERIMENTO
BOL SOLID	30.270.277	LAV.BOLS/RSS

# MONACO

## SOLID SURFACE WASHBASINS



### FEATURES / CARATTERISTICHE

Countertop washbasin  
No overflow. *Lavandino da appoggio.  
Senza sfioratore.*

Matte white  
Bianco opaco

### TECHNICAL INFORMATION / INFORMAZIONI TECNICHE

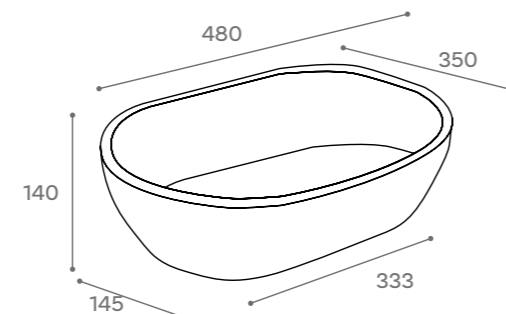

### CODING / CODIFICA

MODEL MODELLO	CODE CODICE	REFERENCE RIFERIMENTO
MONACO SOLID	30.270.277	LAV.MONACO48SS

# DIANA

## SOLID SURFACE WASHBASINS



### FEATURES / CARATTERISTICHE

Countertop washbasin  
No overflow. *Lavandino da appoggio.  
Senza sfioratore.*

Matte white  
Bianco opaco

### TECHNICAL INFORMATION / INFORMAZIONI TECNICHE

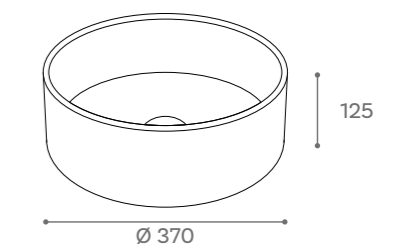

### CODING / CODIFICA

MODEL MODELLO	CODE CODICE	REFERENCE RIFERIMENTO
DIANA SOLID	30.270.277	LAV.DIANA

# BIEL

## SOLID SURFACE WASHBASINS



### FEATURES / CARATTERISTICHE

Countertop washbasin  
No overflow. *Lavandino da appoggio.  
Senza sfioratore.*

Matte white  
Bianco opaco

### TECHNICAL INFORMATION / INFORMAZIONI TECNICHE

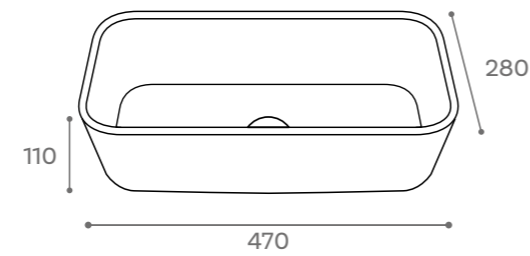

### CODING / CODIFICA

MODEL MODELLO	CODE CODICE	REFERENCE RIFERIMENTO
BIEL SOLID	30.270.277	LAV.BIEL

# ASTRA

## SOLID SURFACE WASHBASINS



### FEATURES / CARATTERISTICHE

Countertop washbasin  
No overflow. *Lavandino da appoggio.  
Senza sfioratore.*

Matte white  
Bianco opaco

### TECHNICAL INFORMATION / INFORMAZIONI TECNICHE

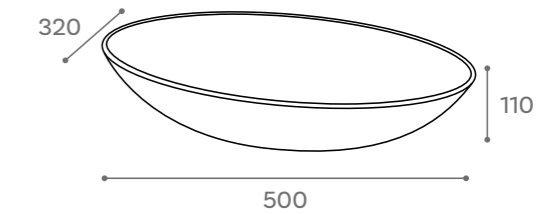

### CODING / CODIFICA

MODEL MODELLO	CODE CODICE	REFERENCE RIFERIMENTO
ASTRA SOLID	30.270.277	LAV.ASTRA

# JUNO

## SOLID SURFACE WASHBASINS



### FEATURES / CARATTERISTICHE

Countertop washbasin  
No overflow. *Lavandino da appoggio.  
Senza sfioratore.*

Matte white  
Bianco opaco

### TECHNICAL INFORMATION / INFORMAZIONI TECNICHE

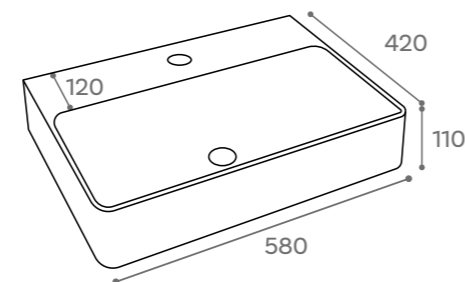

### CODING / CODIFICA

MODEL MODELLO	CODE CODICE	REFERENCE RIFERIMENTO
JUNO SOLID	30.420.277	LAV.JUNO

# ABRIL

## SOLID SURFACE WASHBASINS



### FEATURES / CARATTERISTICHE

Countertop washbasin  
No overflow. *Lavandino da appoggio.  
Senza sfioratore.*

Matte white  
Bianco opaco

### TECHNICAL INFORMATION / INFORMAZIONI TECNICHE

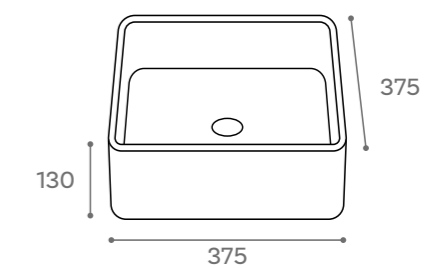

### CODING / CODIFICA

MODEL MODELLO	CODE CODICE	REFERENCE RIFERIMENTO
ABRIL SOLID	30.270.277	LAV.ABRIL



WASHBASINS

*LAVANDINI*

**RESIN STONE**

# HERA

## RESIN STONE WASHBASINS



Hera matte one sink with skirt

### FEATURES / CARATTERISTICHE

Washbasin. One sink with skirt.  
Screws included.  
Towel rail included.  
Includes faucet hole and overflow.

*Lavabo un seno con pannello.  
Viteria inclusa.  
Portasciugamani incluso.  
Include il foro per il rubinetto e lo sfioratore.*

### TECHNICAL INFORMATION / INFORMAZIONI TECNICHE

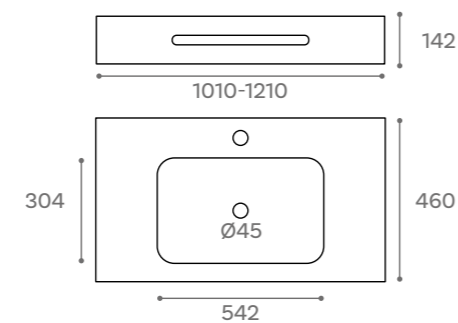

### FINISHING / FINITURA

○ Matte white  
Bianco opaco

### CODING / CODIFICA

MODELLO	CODICE	REFERENCE RIFERIMENTO
HERA MATTE SKIRT 101X46	30.445.277	EGCHRM101X46
HERA MATTE SKIRT 121X46	30.499.277	EGCHRM121x46

# HERA

## RESIN STONE WASHBASINS



Hera matte double sink with skirt

### FEATURES / CARATTERISTICHE

Washbasin. Double sink with skirt.  
Screws included.  
Towel rail included.  
Includes faucet hole and overflow.

*Lavabo doppio seno con pannello.  
Viteria inclusa.  
Portasciugamani incluso.  
Include il foro per il rubinetto e lo sfioratore.*

### TECHNICAL INFORMATION / INFORMAZIONI TECNICHE

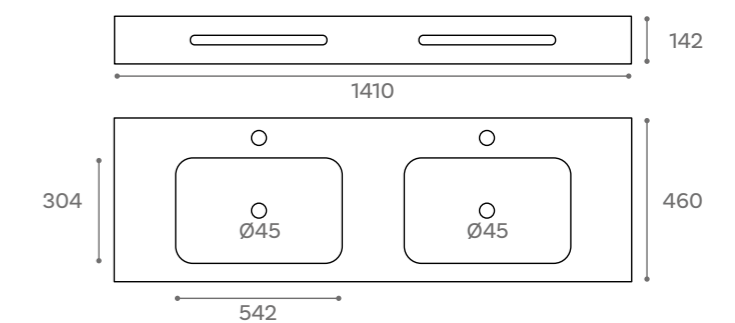

### FINISHING / FINITURA

○ Matte white  
Bianco opaco

### CODING / CODIFICA

MODELLO	CODICE	REFERENCE RIFERIMENTO
HERA DOUBLE SINK WITH MATTE SKIRT 141X46	30.599.277	EGCHRM141D





Hera matte double sink without skirt

### FEATURES / CARATTERISTICHE

Single sink without skirt and double sink without skirt. Includes faucet hole.

*Lavandino un seno senza pannello e doppio seno senza pannello. Include foro per rubinetto.*

### FINISHING / FINITURA

○ Matte white  
Bianco opaco

### CODING / CODIFICA

MODEL MODELLO	CODE CODICE	REFERENCE RIFERIMENTO
HERA MATTE 61X46	30.165.277	EGCH61x46
*HERA MATTE 71X46	30.171.277	EGCH71x46
*HERA MATTE 81X46	30.185.277	EGCH81x46
*HERA MATTE 91X46	30.192.277	EGCH91x46
*HERA MATTE 101X46	30.200.277	EGCH101x46
*HERA MATTE 121X46	30.230.277	EGCH121x46
*HERA LEFT MATTE 101X46	30.208.377	EGCBHR101x46L
*HERA LEFT MATTE 121X46	30.248.377	EGCBHR121x46L
HERA DOUBLE SINK WITHOUT SKIRT 121X46	30.245.277	EGCH121x46-2

### TECHNICAL INFORMATION / INFORMAZIONI TECNICHE

#### ONE SINK / UN SENO

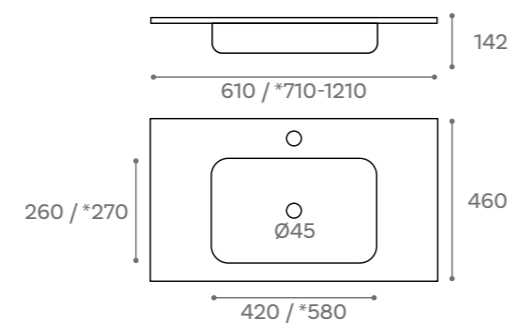

#### DOUBLE SINK / DOPPIO SENO

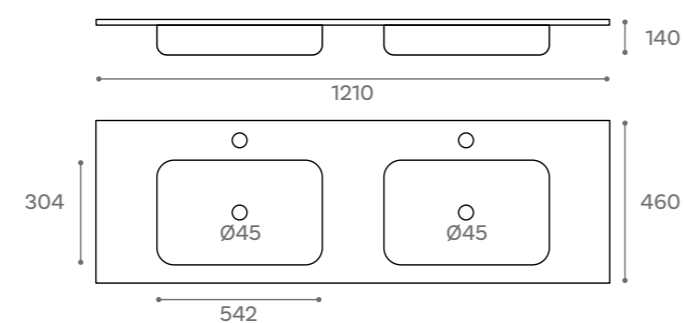

### CODING / CODIFICA

DIMENSIONS MISURE	CODE CODICE	REFERENCE RIFERIMENTO
61x46	30.105.277	RGT61X46
71x46	30.109.277	RGT71X46
81x46	30.111.277	RGT81X46
91x46	30.121.277	RGT91X46
101x46	30.137.277	RGT101X46
121x46	30.163.277	RGT121X46

### TECHNICAL INFORMATION / INFORMAZIONI TECNICHE

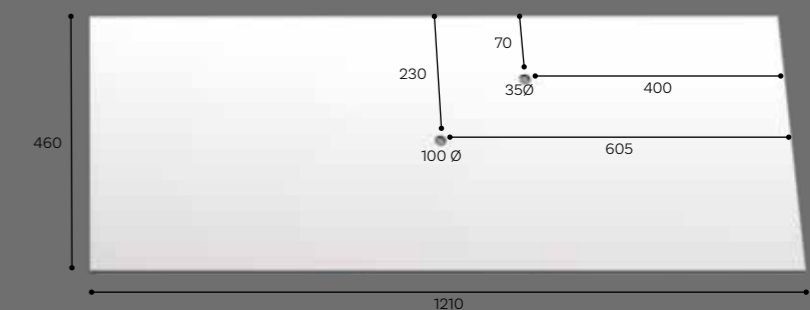
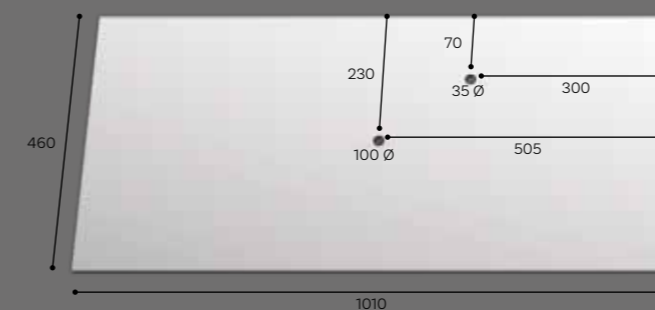
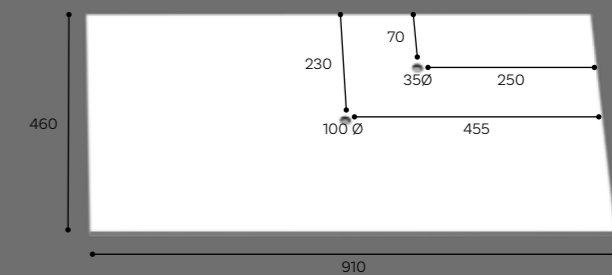
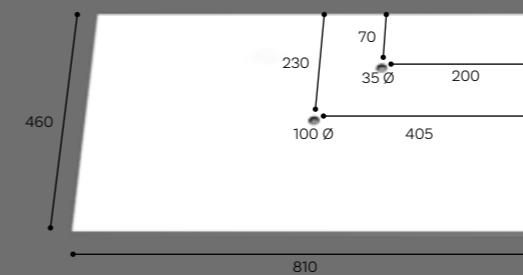
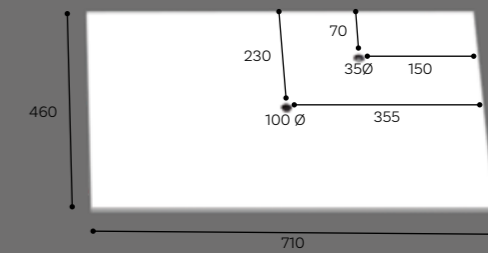
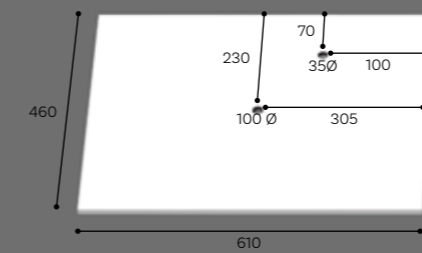

\* These boards will only be delivered machined according to the drawings.  
\* Queste tavole verranno fornite lavorate esclusivamente in base ai piani.

A close-up photograph of water droplets on a white, slightly textured surface. The droplets are of various sizes, some large and prominent, others small and numerous. The lighting is soft, creating gentle highlights and shadows on the droplets' surfaces. The overall composition is clean and minimalist, emphasizing the natural beauty of water.

BATHTUBS

*Vasche da bagno*

## BATHTUBS

Introducing our new series of bathtubs, conceived as modern and versatile elements that integrate seamlessly into your daily life, turning your bathroom space into something unique and personal. Designed to adapt to any environment, these bathtubs turn your bathroom into a contemporary style haven, offering an ideal choice for a variety of aesthetic styles, from minimalist to traditional.

The materials used in our bathtubs are not only aesthetically pleasing, but also guarantee an exceptional bathing experience. The ability to retain water temperature provides unparalleled comfort, allowing you to enjoy relaxing baths without worrying about heat loss. This creates a cozy and pleasant atmosphere every time, enhancing your bathing experience.

We understand the distinctiveness of every bathroom, and our bathtubs are designed to suit this diversity. With a variety of shapes and sizes, we offer flexibility to customize your bathing space according to your needs and preferences. From freestanding bathtubs to those integrated into larger designs, our bathtubs combine modern design and functionality for a unique bathing experience.

Dive into the comfort and well-being of our bathtubs, where every detail has been carefully thought out to make your bathroom a special place.

## VASCHE DA BAGNO

*Vi presentiamo la nostra nuova serie di vasche da bagno, concepite come elementi moderni e versatili che si integrano armoniosamente nella vostra vita quotidiana, trasformando il vostro spazio del bagno in qualcosa di unico e personale. Progettate per adattarsi a qualsiasi ambiente, queste vasche trasformano il vostro bagno in un'oasi di stile contemporaneo, offrendo una scelta ideale per una serie di stili estetici, da quelli minimalisti a quelli tradizionali.*

*I materiali utilizzati nelle nostre vasche non sono solo esteticamente gradevoli, ma garantiscono anche un'esperienza di bagno eccezionale. La capacità di mantenere la temperatura dell'acqua offre un comfort senza pari, consentendo di godersi bagni rilassanti senza preoccuparsi della perdita di calore. Questo crea un'atmosfera accogliente e piacevole in ogni momento, migliorando la vostra esperienza di benessere nel bagno.*

*Comprendiamo l'unicità di ogni bagno e le nostre vasche sono progettate per adattarsi a questa diversità. Con una varietà di forme e dimensioni, offriamo la flessibilità di personalizzare il vostro spazio del bagno in base alle vostre esigenze e preferenze. Dalle vasche freestanding a quelle integrate in progetti più ampi, le nostre vasche combinano design moderno e funzionalità per offrire un'esperienza di bagno unica. Immergetevi nel comfort e nel benessere delle nostre vasche da bagno, dove ogni dettaglio è stato attentamente studiato per rendere il vostro bagno un luogo speciale.*

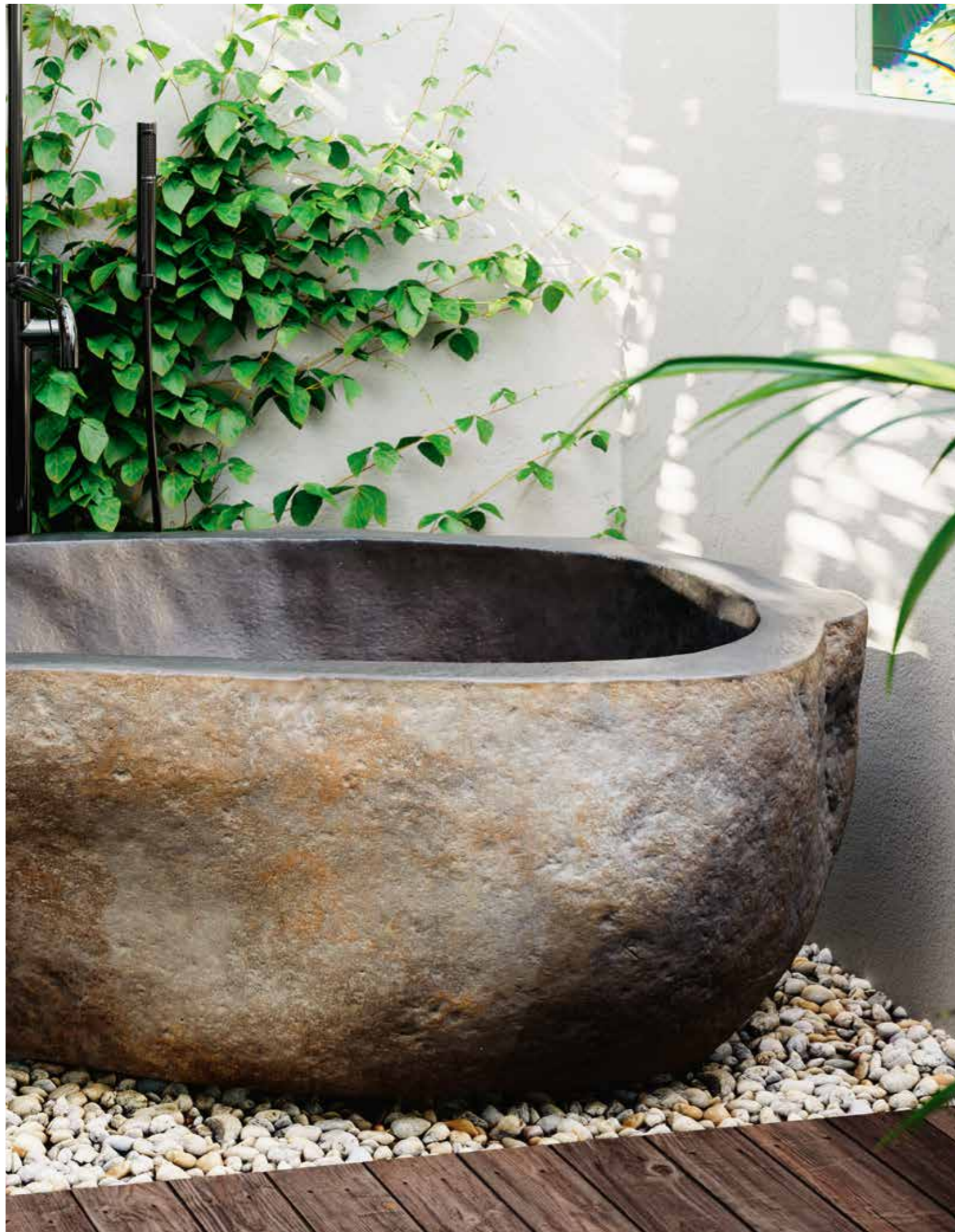

### FEATURES / CARATTERISTICHE

Bathtub made of river stone.  
The sizes, textures and shapes of these bathtubs may vary.  
No overflow and no valve.

*Vasca realizzata con pietra di fiume.  
Le dimensioni, le texture e le forme di queste vasche possono variare.  
Senza sfioratore e senza valvola.*

### FINISHING

#### FINITURA

 River stone  
Pietra di fiume

### CODING / CODIFICA

MODEL  
MODELLO  
MOAI

CODE  
CODICE  
30.3990.277

REFERENCE  
RIFERIMENTO  
BAMOAI-PIE

### TECHNICAL INFORMATION / INFORMAZIONI TECNICHE

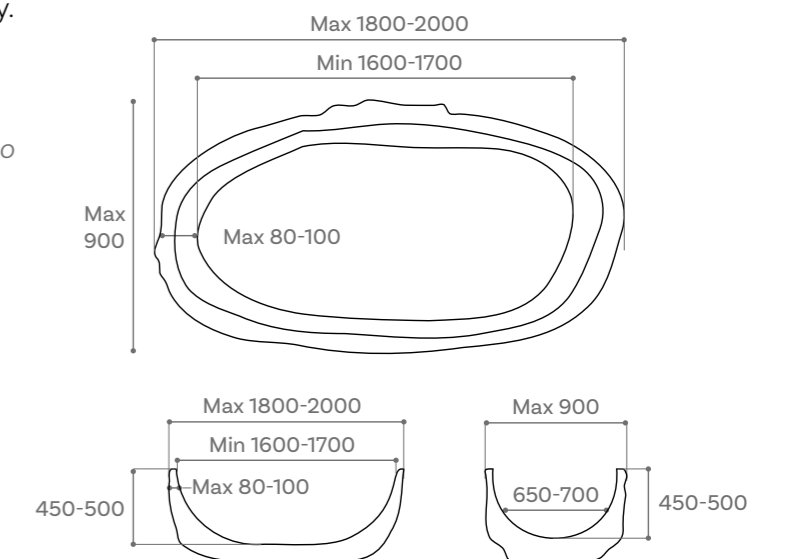

\*Approximate weight of this bathtub is 1,570 kg.  
\*Il peso approssimativo di questa vasca è di 1.570 kg.

\*Check availability.  
\*Consultare disponibilità.

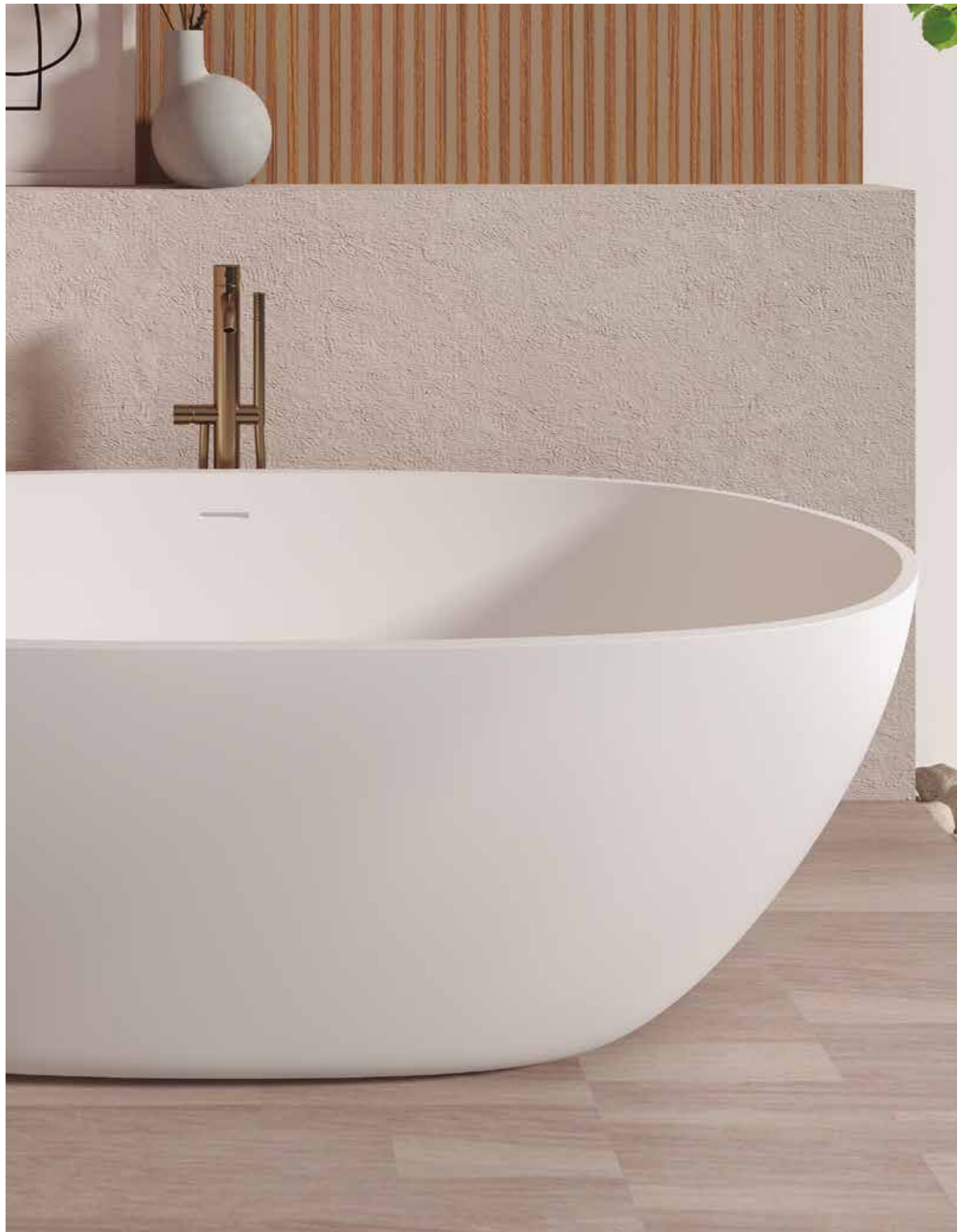

**FEATURES / CARATTERISTICHE**

Bathtub made of solid surface.  
With overflow.  
Chrome-plated valve included.

*Vasca realizzata in solid surface.  
Con sfioratore.  
Con valvola cromata inclusa.*

**FINISHING / FINITURA**

○ Matte white  
Bianco opaco

**CODING / CODIFICA**

MODEL MODELLO	CODE CODICE	REFERENCE RIFERIMENTO
TERRY	30.2600.277	BATE170

**TECHNICAL INFORMATION / INFORMAZIONI TECNICHE**

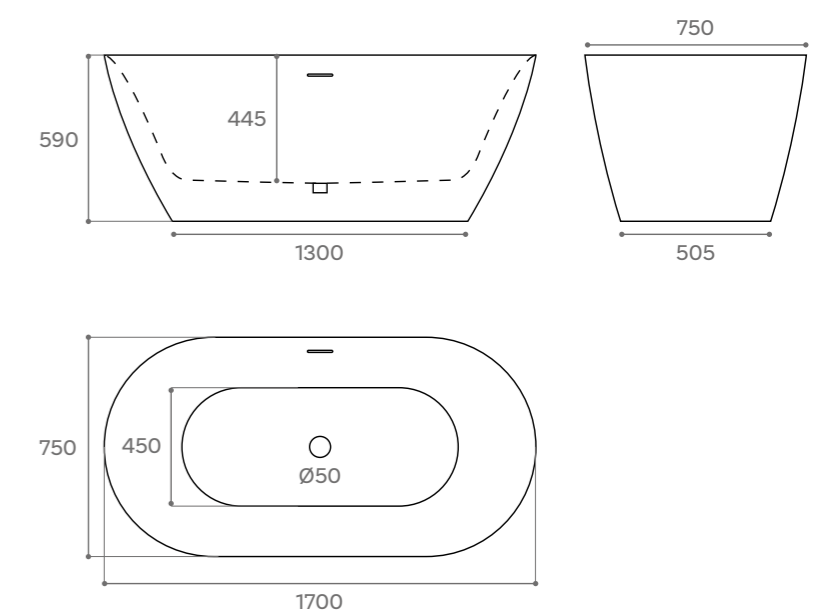



### FEATURES / CARATTERISTICHE

Acrylic bathtub  
With overflow.  
Chrome-plated valve included.  
\*Valve available in matte white or glossy white.

Vasca da bagno in acrilico.  
Con sfioratore.  
Con valvola cromata inclusa.  
\*Valvola disponibile in bianco opaco o lucido.

### FINISHING / FINITURA



### CODING / CODIFICA

MODEL MODELLO	CODE CODICE	REFERENCE RIFERIMENTO
DEBA MATE	30.1375.277	BADEM
DEBA BRILLO	30.1325.277	BADE
*Matte white valve	30.55.277	DEB.BM
*Glossy white valve	30.55.277	DEB.BB

### TECHNICAL INFORMATION / INFORMAZIONI TECNICHE

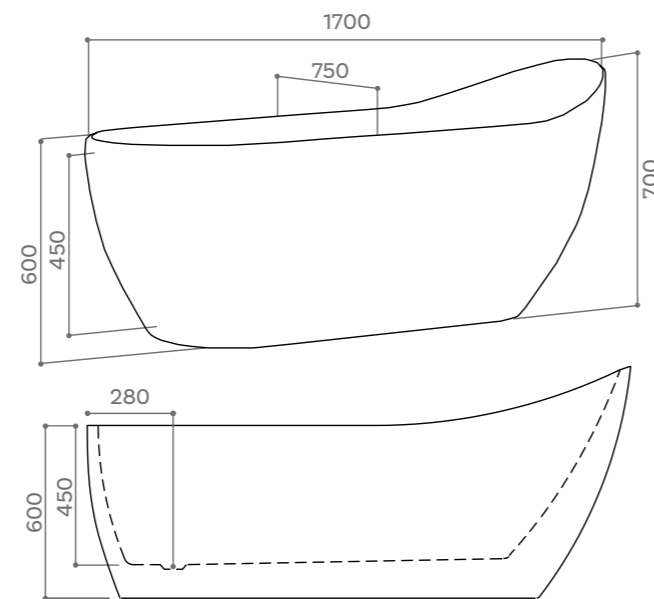

### FEATURES / CARATTERISTICHE

Acrylic bathtub  
With overflow.  
Chrome-plated valve included.  
\*Valve available in glossy white.

Vasca da bagno in acrilico.  
Con sfioratore.  
Con valvola cromata inclusa.  
\*Valvola disponibile in bianco lucido.

### FINISHING / FINITURA



### CODING / CODIFICA

MODEL MODELLO	CODE CODICE	REFERENCE RIFERIMENTO
DUERO	30.1338.277	BAD
*Glossy white valve	30.55.277	DEB.BB

### TECHNICAL INFORMATION / INFORMAZIONI TECNICHE

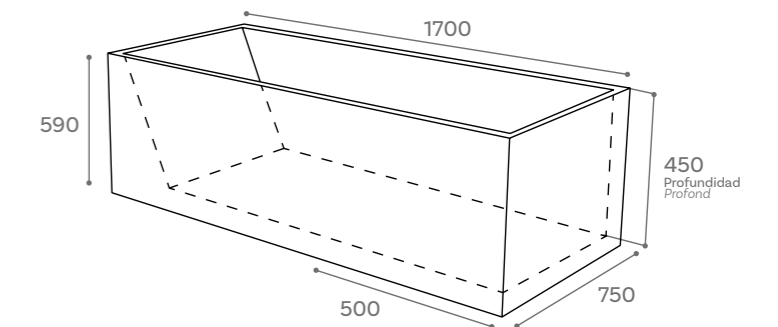

# DANUBIO

BATHTUBS



Danubio glossy

Danubio matte

## FEATURES / CARATTERISTICHE

Acrylic bathtub  
With overflow.  
Chrome-plated valve included.  
\*Valve available in matte white or glossy white.

Vasca da bagno in acrilico.  
Con sfioratore.  
Con valvola cromata inclusa.  
\*Valvola disponibile in bianco opaco o lucido.

## FINISHING / FINITURA



## CODING / CODIFICA

MODEL MODELLO	CODE CODICE	REFERENCE RIFERIMENTO
DANUBIO MATE	30.1295.277	BADAM
DANUBIO BRILLO	30.1225.277	BADA
*Matte white valve	30.55.277	DEB.BM
*Glossy white valve	30.55.277	DEB.BB

## TECHNICAL INFORMATION / INFORMAZIONI TECNICHE

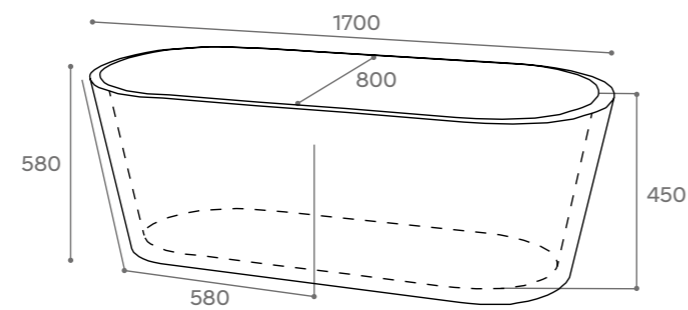

# LOIRA

BATHTUBS



Loira glossy

Loira matte

## FEATURES / CARATTERISTICHE

Acrylic bathtub  
With overflow.  
Chrome-plated valve included.  
\*Valve available in matte white or glossy white.

Vasca da bagno in acrilico.  
Con sfioratore.  
Con valvola cromata inclusa.  
\*Valvola disponibile in bianco opaco o lucido.

## FINISHING / FINITURA



## CODING / CODIFICA

MODEL MODELLO	CODE CODICE	REFERENCE RIFERIMENTO
LOIRA MATE 150	30.1175.277	BALOBM150
LOIRA MATE 170	30.1225.277	BALOBM170
*Matte white valve	30.55.277	DEB.BM

## TECHNICAL INFORMATION / INFORMAZIONI TECNICHE

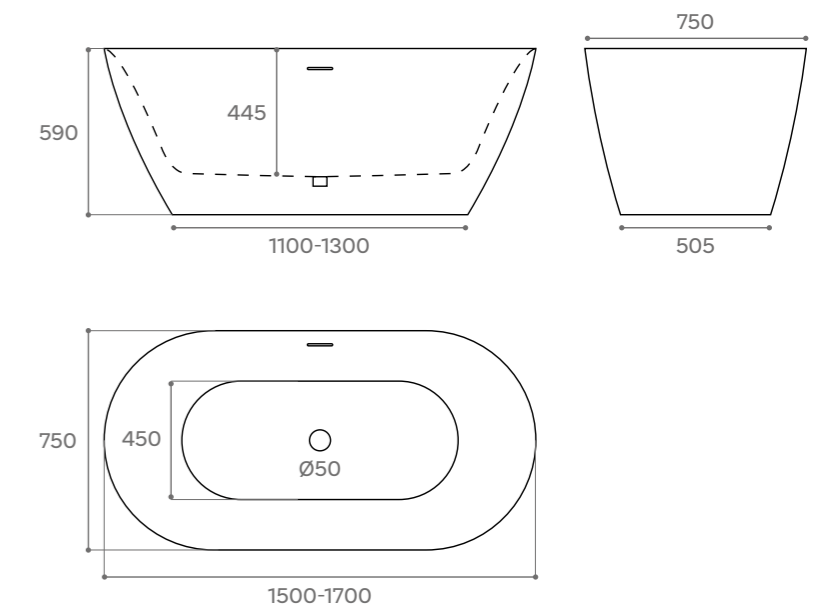



WASHBASINS

LAVANDINI IN PIETRA

**STONE**



# STONE WASHBASINS

Introducing our exceptional collection of stone washbasins, a reliable choice that fuses natural elegance with modernity in bathroom design. These washbasins go beyond being simple accessories, becoming authentic works of natural art. With a variety of authentic colors and shapes ranging from precise geometric to fluid asymmetrical, each washbasin becomes a unique expression of natural beauty.

Stone, in addition to its aesthetic appeal, brings durability and sophistication to each washbasin. From captivatingly veined marbles to uniquely textured stones, each piece is designed to blend seamlessly into your bathroom space. The inherent strength of stone ensures a long service life, while its luxurious presence elevates the sophistication of your bathroom.

Our careful washbasin selection reflects our commitment to authenticity and quality. Each piece represents a genuine connection to natural beauty, creating a shrine of lasting elegance in your bathroom. Discover the perfect fusion of modern functionality and inspiration from nature, turning your space into a haven of luxury and wellness.

# LAVANDINI IN PIETRA

*Vi presentiamo la nostra eccezionale collezione di lavabi in pietra, una scommessa sicura che fonde l'eleganza naturale e la modernità nel design del bagno. Questi lavabi vanno oltre il semplice accessorio, e diventano vere e proprie opere d'arte naturale. Con una varietà di colori autentici e forme che vanno dal geometrico preciso alle asimmetrie fluide, ogni lavandino diventa un'espressione unica della bellezza naturale.*

*Oltre al suo fascino estetico, la pietra conferisce durevolezza e raffinatezza ad ogni lavandino. Da marmi dalle venature accattivanti a pietre dalle texture uniche, ogni pezzo è progettato per integrarsi perfettamente nel vostro spazio del bagno. La resistenza intrinseca della pietra garantisce una lunga durata, mentre la sua presenza lussuosa eleva la raffinatezza del vostro bagno.*

*La nostra accurata selezione di lavandini riflette il nostro impegno nei confronti dell'autenticità e della qualità. Ogni pezzo rappresenta un legame genuino con la bellezza naturale, creando un santuario di eleganza duratura nel vostro bagno. Scoprite la perfetta fusione tra la funzionalità moderna e l'ispirazione dalla natura, trasformando il vostro spazio in un'oasi di lusso e benessere.*

# AKUTAN

## STONE WASHBASINS



### FEATURES / CARATTERISTICHE

Countertop washbasin  
 Made of river stone.  
 No overflow.  
 The sizes, textures and shapes of these washbasins may vary.

*Lavandino da appoggio.  
 Lavandino realizzato con pietra di fiume.  
 Senza sfioratore.  
 Le dimensioni, le texture e le forme di questi lavandini possono variare.*

### FINISHING / FINITURA

 River stone  
 Pietra di fiume

### CODING / CODIFICA

MODEL MODELLO	CODE CODICE	REFERENCE RIFERIMENTO
AKUTAN	30.210.277	LAV.AKUNATURE
AKUTAN XL	30.390.277	LAV.AKUTANXL

### TECHNICAL INFORMATION / INFORMAZIONI TECNICHE

AKUTAN 450x150mm



AKUTAN XL

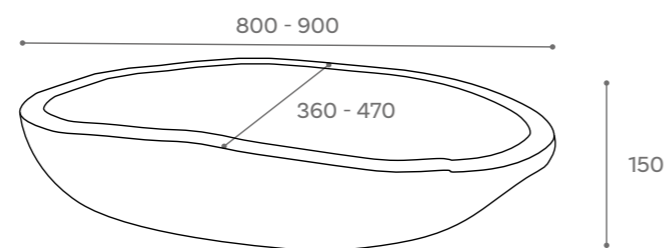

# TOTEM

## STONE WASHBASINS



### FEATURES CARATTERISTICHE

Floor-standing washbasin.  
 Made of river stone.  
 No overflow.  
 The sizes, textures and shapes of these washbasins may vary.

*Lavandino con colonna.  
 Lavandino realizzato con pietra di fiume.  
 Senza sfioratore.  
 Le dimensioni, le texture e le forme di questi lavandini possono variare.*

### FINISHING FINITURA

 River stone  
 Pietra di fiume

### TECHNICAL INFORMATION INFORMAZIONI TECNICHE

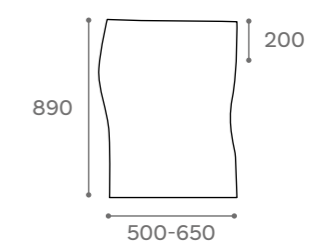
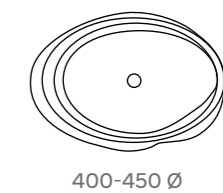

 \*Approximate weight of this washbasin is 225 kg  
 \*Il peso approssimativo di questo lavandino è di 225 kg

### CODING CODIFICA

MODEL MODELLO	CODE CODICE	REFERENCE RIFERIMENTO
TOTEM	30.750.277	LAV.TOTEM

# DAKOTA

## STONE WASHBASINS



### FEATURES / CARATTERISTICHE

Countertop washbasin  
No overflow.  
Made in marble.  
The textures and colors of these washbasins may vary.

*Lavandino da appoggio.  
Senza sfioratore.  
Realizzato in marmo.  
Le texture e i colori di questi lavandini possono variare.*

### TECHNICAL INFORMATION / INFORMAZIONI TECNICHE

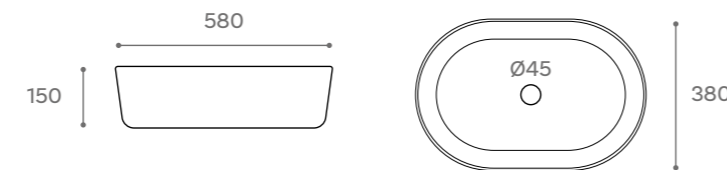

### FINISHING / FINITURA

 Beige marble  
Marmo beige

### CODING / CODIFICA

MODEL MODELLO	CODE CODICE	REFERENCE RIFERIMENTO
DAKOTA BEIGE	30.350.277	LAV.DAKOTA

# GEA

## STONE WASHBASINS



### FEATURES / CARATTERISTICHE

Countertop washbasin  
No overflow.  
Made in marble.

*Lavandino da appoggio.  
Senza sfioratore.  
Realizzato in marmo.*

 Black marble  
Marmo nero.

### TECHNICAL INFORMATION / INFORMAZIONI TECNICHE

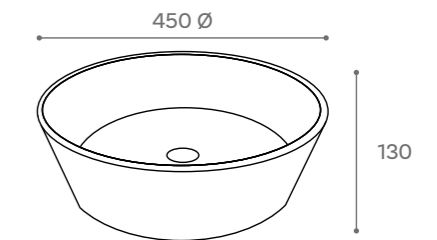

### CODING / CODIFICA

MODEL MODELLO	CODE CODICE	REFERENCE RIFERIMENTO
GEA	30.290.277	LAV.GEA

# TEXAS

## STONE WASHBASINS



### FEATURES / CARATTERISTICHE

Countertop washbasin  
No overflow.  
Made in marble.

*Lavandino da appoggio.  
Senza sfioratore.  
Realizzato in marmo.*

 Black marble  
Marmo nero.

### TECHNICAL INFORMATION / INFORMAZIONI TECNICHE

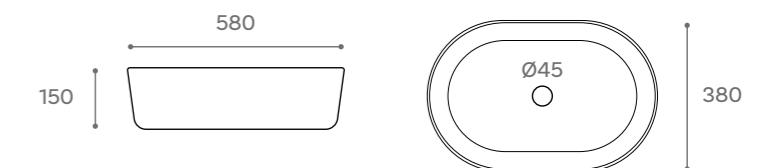

### CODING / CODIFICA

MODEL MODELLO	CODE CODICE	REFERENCE RIFERIMENTO
TEXAS GRIS	30.350.277	LAV.TEXAS

The textures and colors of these washbasins may vary.  
*Le texture e i colori di questi lavandini possono variare.*

# ADWA

## STONE WASHBASINS



Adwa fine



Adwa nature

### FEATURES / CARATTERISTICHE

Countertop washbasin  
No overflow.  
Made in marble.  
The textures and colors of these washbasins may vary.

*Lavandino da appoggio.  
Senza sfioratore.  
Realizzato in marmo.  
Le texture e i colori di questi lavandini possono variare.*

### TECHNICAL INFORMATION / INFORMAZIONI TECNICHE

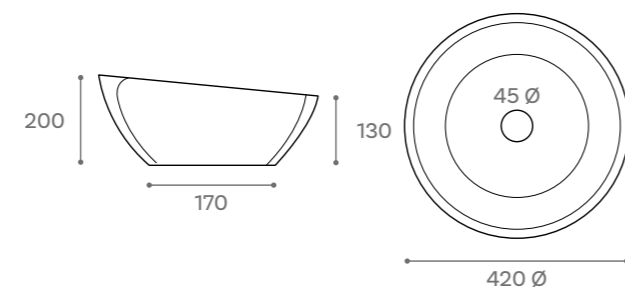

### FINISHING / FINITURA



### CODING / CODIFICA

FINISHING FINITURA	CODE CODICE	REFERENCE RIFERIMENTO
ADWA FINE	30.290.277	LAV.ADWAF
ADWA NATURE	30.290.277	LAV.ADWAN

# ABU

## STONE WASHBASINS



Abu gray



Abu beige

### FEATURES / CARATTERISTICHE

Countertop washbasin  
No overflow.  
Made in marble.  
The textures and colors of these washbasins may vary.

*Lavandino da appoggio.  
Senza sfioratore.  
Realizzato in marmo.  
Le texture e i colori di questi lavandini possono variare.*

### TECHNICAL INFORMATION / INFORMAZIONI TECNICHE

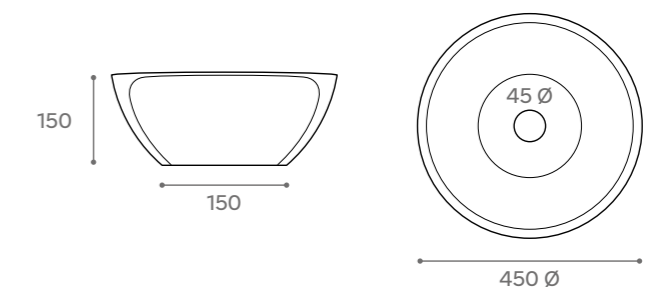

### FINISHING / FINITURA



### CODING / CODIFICA

FINISHING FINITURA	CODE CODICE	REFERENCE RIFERIMENTO
ABU GRAY	30.290.277	LAV.ABU.GRIS
ABU BEIGE	30.290.277	LAV.ABU.BEI

# DANA

## STONE WASHBASINS



Dana beige



Dana black

### FEATURES / CARATTERISTICHE

Countertop washbasin  
No overflow.  
Made in marble.  
The textures and colors of these washbasins may vary.

*Lavandino da appoggio.  
Senza sfioratore.  
Realizzato in marmo.  
Le texture e i colori di questi lavandini possono variare.*

### TECHNICAL INFORMATION / INFORMAZIONI TECNICHE



### FINISHING / FINITURA



### CODING / CODIFICA

FINISHING FINITURA	CODE CODICE	REFERENCE RIFERIMENTO
DANA BEIGE	30.290.277	LAV.DANA.BEI
DANA BLACK	30.290.277	LAV.DANA.NEG

# BERU

## STONE WASHBASINS



Beru beige



Beru black

### FEATURES / CARATTERISTICHE

Countertop washbasin  
No overflow.  
Made in marble.  
The textures and colors of these washbasins may vary.

*Lavandino da appoggio.  
Senza sfioratore.  
Realizzato in marmo.  
Le texture e i colori di questi lavandini possono variare.*

### TECHNICAL INFORMATION / INFORMAZIONI TECNICHE

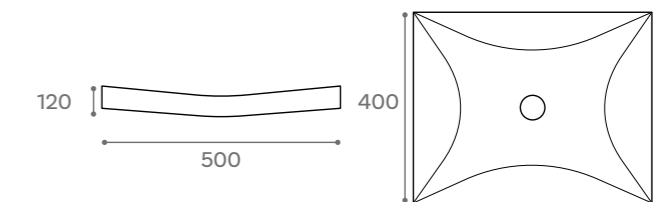

### FINISHING / FINITURA



### CODING / CODIFICA

FINISHING FINITURA	CODE CODICE	REFERENCE RIFERIMENTO
BERU BEIGE	30.290.277	LAV.BERU.BEI
BERU BLACK	30.290.277	LAV.BERU.NEG

# BELENUS

## STONE WASHBASINS



### FEATURES / CARATTERISTICHE

Countertop washbasin  
No overflow.  
Made in marble.

*Lavandino da appoggio.  
Senza sfioratore.  
Realizzato in marmo.*



### TECHNICAL INFORMATION / INFORMAZIONI TECNICHE

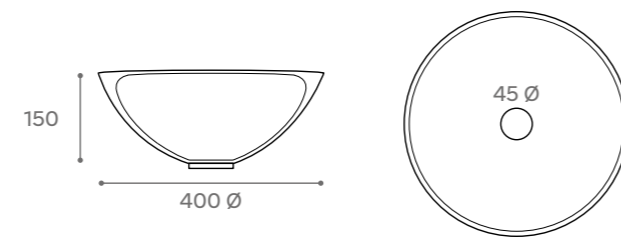

### CODING / CODIFICA

MODEL MODELLO	CODE CODICE	REFERENCE RIFERIMENTO
BELENUS	30.290.277	LAV.BELENUS

The textures and colors of these washbasins may vary.  
*Le texture e i colori di questi lavandini possono variare.*

# NAVIA

## STONE WASHBASINS



### FEATURES / CARATTERISTICHE

Countertop washbasin  
No overflow.  
Made in marble.

*Lavandino da appoggio.  
Senza sfioratore.  
Realizzato in marmo.*



### TECHNICAL INFORMATION / INFORMAZIONI TECNICHE

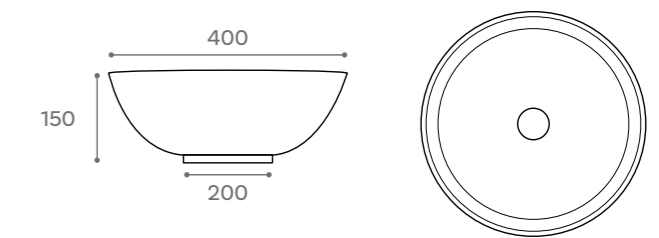

### CODING / CODIFICA

MODEL MODELLO	CODE CODICE	REFERENCE RIFERIMENTO
NAVIA	30.290.277	LAV.NAVIA

The textures and colors of these washbasins may vary.  
*Le texture e i colori di questi lavandini possono variare.*

# RACE

## STONE WASHBASINS



### FEATURES / CARATTERISTICHE

Countertop washbasin  
No overflow.  
Made in marble.

*Lavandino da appoggio.  
Senza sfioratore.  
Realizzato in marmo.*



### TECHNICAL INFORMATION / INFORMAZIONI TECNICHE

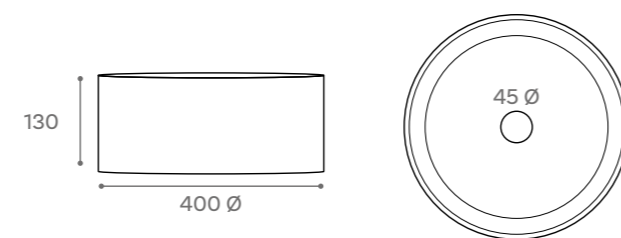

### CODING / CODIFICA

MODEL MODELLO	CODE CODICE	REFERENCE RIFERIMENTO
RACE	30.290.277	LAV.RACE

The textures and colors of these washbasins may vary.  
*Le texture e i colori di questi lavandini possono variare.*

# ARAMO

## STONE WASHBASINS



### FEATURES / CARATTERISTICHE

Countertop washbasin  
No overflow.  
Made in marble.

*Lavandino da appoggio.  
Senza sfioratore.  
Realizzato in marmo.*



### TECHNICAL INFORMATION / INFORMAZIONI TECNICHE

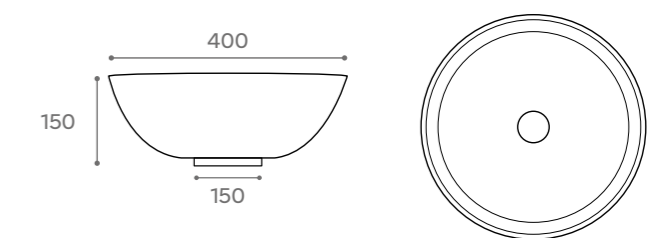

### CODING / CODIFICA

MODEL MODELLO	CODE CODICE	REFERENCE RIFERIMENTO
ARAMO	30.290.277	LAV.ARAMO

The textures and colors of these washbasins may vary.  
*Le texture e i colori di questi lavandini possono variare.*

# PETRA

## STONE WASHBASINS



### FEATURES / CARATTERISTICHE

Countertop washbasin  
No overflow.  
Made of petrified wood.  
The sizes and textures of these washbasins may vary.

*Lavandino da appoggio.  
Senza sfioratore.  
Realizzato in legno pietrificato.  
Le dimensioni e le texture di questi lavandini possono variare.*

### TECHNICAL INFORMATION / INFORMAZIONI TECNICHE

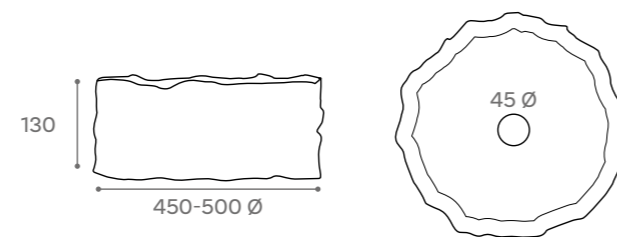

### FINISHING / FINITURA

 Petrified wood  
Legno pietrificato

### CODING / CODIFICA

MODEL MODELLO	CODE CODICE	REFERENCE RIFERIMENTO
PETRA	30.380.277	LAV.PETRA

# DETROIT

## STONE WASHBASINS



### FEATURES CARATTERISTICHE

Floor-standing washbasin.  
No overflow.  
Made in marble.  
The textures and colors of these washbasins may vary.

*Lavandino con colonna.  
Senza sfioratore.  
Realizzato in marmo.  
Le texture e i colori di questi lavandini possono variare.*

### FINISHING FINITURA

 Beige marble  
Marmo beige

### TECHNICAL INFORMATION INFORMAZIONI TECNICHE

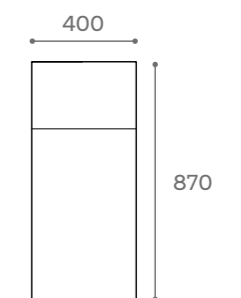
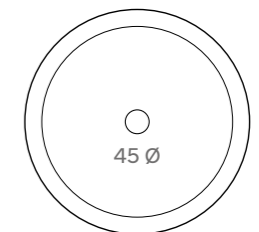

### CODING CODIFICA

MODEL MODELLO	CODE CODICE	REFERENCE RIFERIMENTO
DETROIT	30.750.277	LAV.DETROIT

# ICON

## STONE WASHBASINS



### FEATURES CARATTERISTICHE

Floor-standing washbasin.  
No overflow.  
Made in marble.  
The textures and colors of these washbasins may vary.

*Lavandino con colonna.  
Senza sfioratore.  
Realizzato in marmo.  
Le texture e i colori di questi lavandini possono variare.*

### FINISHING FINITURA



### TECHNICAL INFORMATION INFORMAZIONI TECNICHE

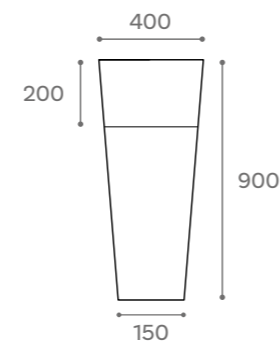
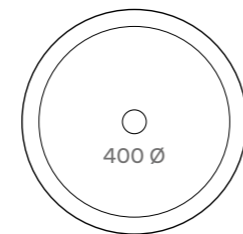

### CODING CODIFICA

MODEL MODELLO	CODE CODICE	REFERENCE RIFERIMENTO
ICON	30.750.277	LAV.ICON

# EOS

## STONE WASHBASINS



### FEATURES CARATTERISTICHE

Floor-standing washbasin.  
No overflow.  
Made in marble.  
The textures and colors of these washbasins may vary.

*Lavandino con colonna.  
Senza sfioratore.  
Realizzato in marmo.  
Le texture e i colori di questi lavandini possono variare.*

### FINISHING FINITURA

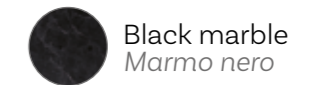

### TECHNICAL INFORMATION INFORMAZIONI TECNICHE

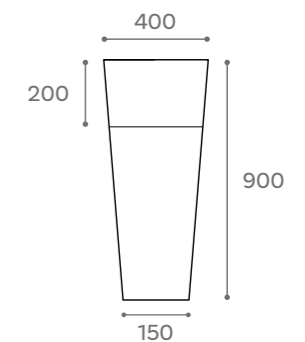
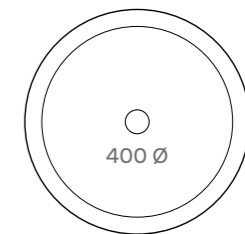

### CODING CODIFICA

MODEL MODELLO	CODE CODICE	REFERENCE RIFERIMENTO
EOS	30.800.277	LAV.EOS





WASHBASINS

LAVANDINI DA APPOGGIO

**COUNTERTOP**

## COUNTERTOP WASHBASINS

Ceramic countertop washbasins are renowned for their classic styling and exceptional durability. Made of high temperature hardened clay, they offer timeless aesthetics and resistance to impact and stains. Their non-porous surface makes daily cleaning easy, and their versatility in shapes and sizes suits a variety of design needs.

Compatible with a variety of faucets and accessories, ceramic washbasins are ideal for traditional or modern bathrooms. In addition, their resistance to heat and moisture makes them suitable for bathroom environments.

Ceramic washbasins, belonging to a range of premium ceramic material, add simplicity and lightness on an aesthetic level. At Art&bath, we are proud to offer a wide range of colors, shapes and finishes to provide you with varied and customized options to suit your preferences and design needs.

## LAVANDINI DA APPOGGIO

*I lavandini da appoggio in ceramica sono rinomati per il loro stile classico e l'eccezionale durevolezza. Realizzati in argilla indurita ad alta temperatura, offrono un'estetica atemporale e una resistenza agli urti e alle macchie. La loro superficie non porosa facilita la pulizia quotidiana e la loro versatilità di forme e dimensioni si adatta a diverse esigenze di design.*

*Compatibili con una vasta gamma di rubinetti e accessori, i lavandini in ceramica sono ideali per bagni tradizionali o moderni. Inoltre, la loro resistenza al calore e all'umidità li rende adatti agli ambienti bagno.*

*I lavandini in ceramica, appartenenti a una gamma di materiali ceramici di alta qualità, aggiungono semplicità e leggerezza a livello estetico. Noi di Art&bath siamo orgogliosi di offrire un'ampia gamma di colori, forme e finiture per offrirvi opzioni varie e personalizzate che si adattino alle vostre preferenze ed esigenze di design.*





### FEATURES / CARATTERISTICHE

Countertop washbasin  
No overflow.  
Porcelain.

*Lavandino da appoggio.  
Senza sfioratore.  
Porcellana.*

### FINISHING / FINITURA

-  Matte white  
Bianco opaco
-  Glossy white  
Bianco lucido
-  Matte black  
Nero opaco

### CODING / CODIFICA

MODEL MODELLO	CODE CODICE
VITO MATTE WHITE	30.370.277
VITO MATTE BLACK	30.410.277
VITO GLOSSY WHITE	30.290.277

### TECHNICAL INFORMATION / INFORMAZIONI TECNICHE

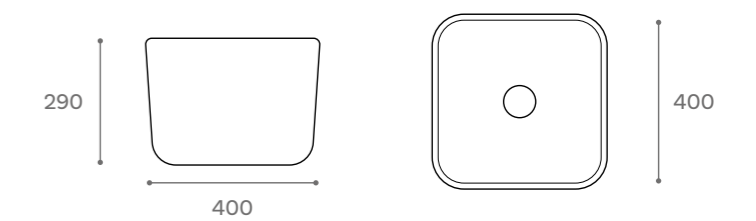

### OPTIONAL VALVES / VALVOLE OPZIONALI

-  Glossy white  
Bianco lucido
-  Matte white  
Bianco opaco
-  Matte black  
Nero opaco

REFERENCE RIFERIMENTO	MODEL MODELLO	CODE CODICE	REFERENCE RIFERIMENTO
LAV.VITOBM	GLOSSY WHITE VALVE	30.19.277	VALUNI.L.P
LAV.VITONM	MATTE WHITE VALVE	30.24.277	VALUNI.BMC
LAV.VITOB	MATTE BLACK VALVE	30.24.277	VALUNI.NMC



Furnas matte white



Furnas glossy white





Furnas matte black

### FEATURES / CARATTERISTICHE

Countertop washbasin  
No overflow.  
With faucet hole.

*Lavandino da appoggio.  
Senza sfioratore.  
Con foro per rubinetto.*

### FINISHING / FINITURA

-  Matte white  
Bianco opaco
-  Matte black  
Nero opaco
-  Glossy white  
Bianco lucido

### CODING / CODIFICA

MODELLO	CODE	REFERIMENTO	MODELLO	CODE	REFERIMENTO
FURNAS MATTE WHITE	30.161.277	LAV.FURNASBM	GLOSSY WHITE VALVE	30.19.277	VALUNI.L.P
FURNAS MATTE BLACK	30.161.277	LAV.FURNASN	MATTE WHITE VALVE	30.24.277	VALUNI.BMC
FURNAS GLOSSY WHITE	30.105.277	LAV.FURNASBB	MATTE BLACK VALVE	30.24.277	VALUNI.NMC

### TECHNICAL INFORMATION / INFORMAZIONI TECNICHE

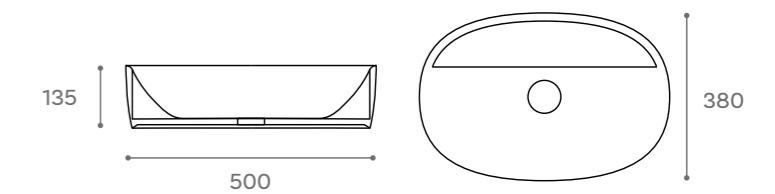

### OPTIONAL VALVES / VALVOLE OPZIONALI

-   
Glossy white  
Bianco lucido
-   
Matte white  
Bianco opaco
-   
Matte black  
Nero opaco

# EUROPE

## COUNTERTOP WASHBASINS



### FEATURES / CARATTERISTICHE

Countertop washbasin  
No overflow.  
White porcelain.

*Lavandino da appoggio.  
Senza sfioratore.  
Porcellana bianca.*

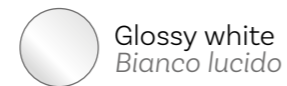

### TECHNICAL INFORMATION / INFORMAZIONI TECNICHE

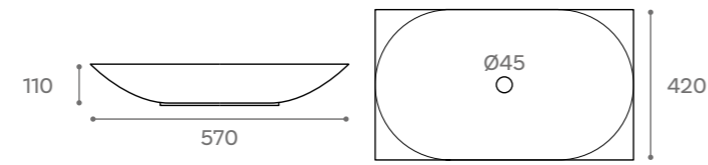

### CODING / CODIFICA

MODEL MODELLO	CODE CODICE	REFERENCE RIFERIMENTO
EUROPA	30.127.277	LAV. EUROPA

# ARA

## COUNTERTOP WASHBASINS



### FEATURES / CARATTERISTICHE

Countertop washbasin  
With overflow.  
With faucet hole.  
White porcelain.

*Lavandino da appoggio.  
Con sfioratore.  
Con foro per rubinetto.  
Porcellana bianca.*



### TECHNICAL INFORMATION / INFORMAZIONI TECNICHE

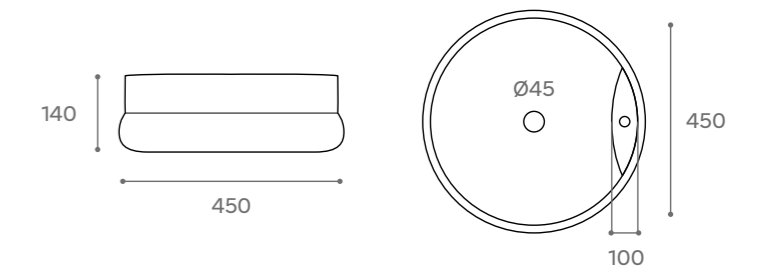

### CODING / CODIFICA

MODEL MODELLO	CODE CODICE	REFERENCE RIFERIMENTO
ARA	30.121.277	LAV.ARA

# DALLAS

## COUNTERTOP WASHBASINS



### FEATURES / CARATTERISTICHE

Countertop washbasin  
No overflow.  
White porcelain.

*Lavandino da appoggio.  
Senza sfioratore.  
Porcellana bianca.*

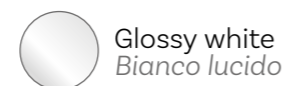

### TECHNICAL INFORMATION / INFORMAZIONI TECNICHE

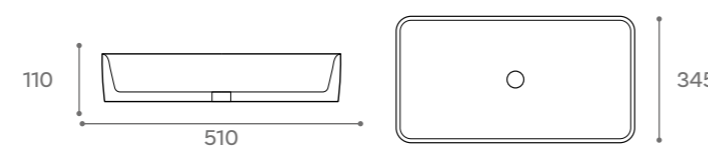

### CODING / CODIFICA

MODEL MODELLO	CODE CODICE	REFERENCE RIFERIMENTO
DALLAS	30.105.277	LAV.DALLAS

# TORMES

## COUNTERTOP WASHBASINS



### FEATURES / CARATTERISTICHE

Countertop washbasin  
With overflow.  
With faucet hole.  
White porcelain.

*Lavandino da appoggio.  
Con sfioratore.  
Con foro per rubinetto.  
Porcellana bianca.*



### TECHNICAL INFORMATION / INFORMAZIONI TECNICHE

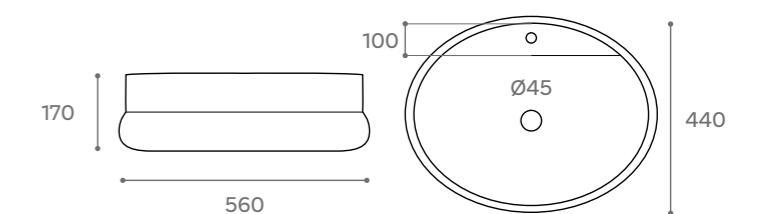

### CODING / CODIFICA

MODEL MODELLO	CODE CODICE	REFERENCE RIFERIMENTO
TORMES	30.131.277	LAV.TORMES

# SIL

## COUNTERTOP WASHBASINS



### FEATURES / CARATTERISTICHE

Countertop washbasin  
With overflow.  
With faucet hole.  
White porcelain.

*Lavandino da appoggio.  
Con sfioratore.  
Con foro per rubinetto.  
Porcellana bianca.*

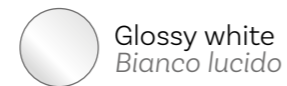

### TECHNICAL INFORMATION / INFORMAZIONI TECNICHE

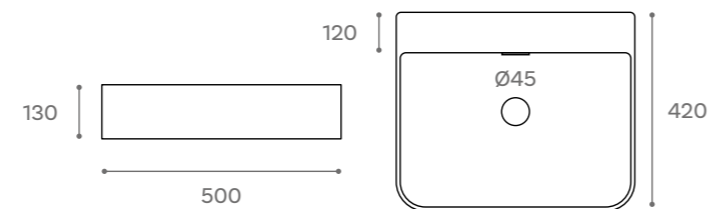

### CODING / CODIFICA

MODEL MODELLO	CODE CODICE	REFERENCE RIFERIMENTO
SIL	30.151.277	LAV.SIL

# ONTARIO

## COUNTERTOP WASHBASINS



### FEATURES / CARATTERISTICHE

Semi-recessed washbasin.  
No overflow.  
White porcelain.

*Lavandino a semincasso.  
Senza sfioratore.  
Porcellana bianca.*



### TECHNICAL INFORMATION / INFORMAZIONI TECNICHE

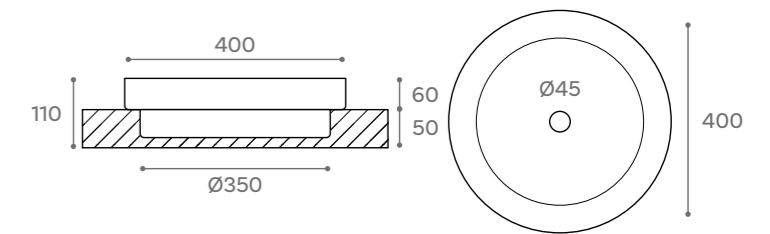

### CODING / CODIFICA

MODEL MODELLO	CODE CODICE	REFERENCE RIFERIMENTO
ONTARIO	30.92.277	LAV.ONT

# EUME

## COUNTERTOP WASHBASINS



### FEATURES / CARATTERISTICHE

Countertop washbasin  
With overflow.  
With faucet hole.  
White porcelain.

*Lavandino da appoggio.  
Con sfioratore.  
Con foro per rubinetto.  
Porcellana bianca.*

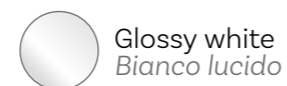

### TECHNICAL INFORMATION / INFORMAZIONI TECNICHE

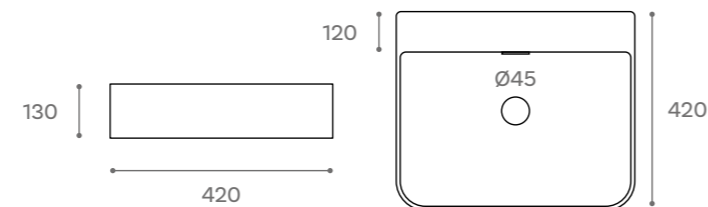

### CODING / CODIFICA

MODEL MODELLO	CODE CODICE	REFERENCE RIFERIMENTO
EUME	30.130.277	LAV.EUME

# QUEBEC

## COUNTERTOP WASHBASINS



### FEATURES / CARATTERISTICHE

Semi-recessed washbasin.  
With overflow.  
White porcelain.

*Lavandino a semincasso.  
Con sfioratore.  
Porcellana bianca.*



### TECHNICAL INFORMATION / INFORMAZIONI TECNICHE

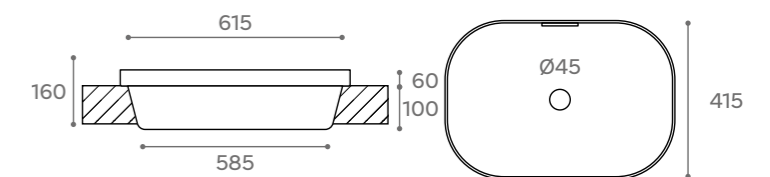

### CODING / CODIFICA

MODEL MODELLO	CODE CODICE	REFERENCE RIFERIMENTO
QUEBEC	30.121.277	LAV.QUE

# MÓNACO 48

## COUNTERTOP WASHBASINS



Mónaco glossy white



Mónaco glossy black

### FEATURES / CARATTERISTICHE

Countertop washbasin  
No overflow.  
Porcelain.

*Lavandino da appoggio.  
Senza sfioratore.  
Porcellana.*

### FINISHING / FINITURA



### TECHNICAL INFORMATION / INFORMAZIONI TECNICHE

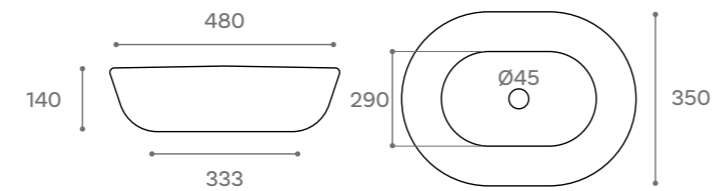

### OPTIONAL VALVES / VALVOLE OPZIONALI



Glossy white  
Bianco lucido



Glossy black  
Nero lucido

### CODING / CODIFICA

MODEL MODELLO	CODE CODICE	REFERENCE RIFERIMENTO	MODEL MODELLO	CODE CODICE	REFERENCE RIFERIMENTO
MONACO 48	30.92.277	LAV.MONACO48	GLOSSY WHITE VALVE	30.19.277	VALUNI.L.P
MONACO BLACK	30.155.277	LAV.MON.NE	GLOSSY BLACK VALVE	30.20.277	VALUNI.L.NB

# MÓNACO 60

## COUNTERTOP WASHBASINS



### FEATURES / CARATTERISTICHE

Countertop washbasin  
No overflow.  
White porcelain.

*Lavandino da appoggio.  
Senza sfioratore.  
Porcellana bianca.*



### TECHNICAL INFORMATION / INFORMAZIONI TECNICHE

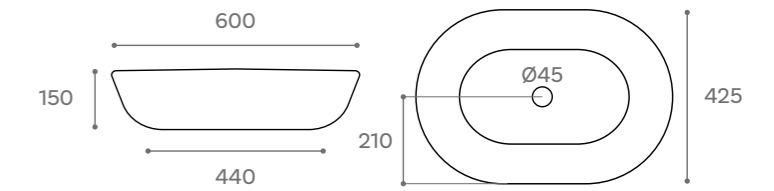

### CODING / CODIFICA

MODEL MODELLO	CODE CODICE	REFERENCE RIFERIMENTO
MONACO 60	30.109.277	LAV.MONACO60

# OBI

## COUNTERTOP WASHBASINS



### FEATURES / CARATTERISTICHE

Countertop washbasin  
No overflow.  
White porcelain.

*Lavandino da appoggio.  
Senza sfioratore.  
Porcellana bianca.*



### TECHNICAL INFORMATION / INFORMAZIONI TECNICHE

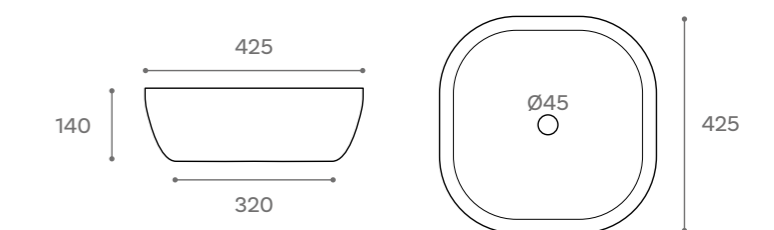

### CODING / CODIFICA

MODEL MODELLO	CODE CODICE	REFERENCE RIFERIMENTO
OBI	30.92.277	LAV.OBI



Bol matte white



Bol glossy white





Bol matte black

### FEATURES / CARATTERISTICHE

Countertop washbasin  
No overflow.  
Porcelain.

*Lavandino da appoggio.*  
*Senza sfioratore.*  
*Porcellana.*

### FINISHING / FINITURA

-  Matte white  
Bianco opaco
-  Matte black  
Nero opaco
-  Glossy white  
Bianco lucido

### CODING / CODIFICA

MODEL MODELLO	CODE CODICE
BOL MATTE WHITE	30.162.277
BOL MATTE BLACK	30.168.277
BOL GLOSSY WHITE	30.101.277
*BOL GLOSSY WHITE MINI	30.82.277

### TECHNICAL INFORMATION / INFORMAZIONI TECNICHE

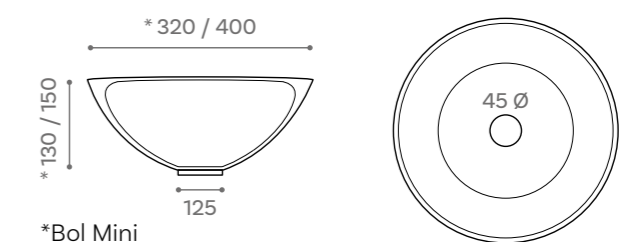

\*Bol Mini

### OPTIONAL VALVES / VALVOLE OPZIONALI



Glossy white  
Bianco lucido

Matte white  
Bianco opaco

Matte black  
Nero opaco

REFERENCE RIFERIMENTO	MODEL MODELLO	CODE CODICE	REFERENCE RIFERIMENTO
LAV.BOLBM	GLOSSY WHITE VALVE	30.19.277	VALUNI.L.P
LAV.BOL.NEG	MATTE WHITE VALVE	30.24.277	VALUNI.BMC
LAV.BOL.EXT	MATTE BLACK VALVE	30.24.277	VALUNI.NMC
LAV.BOL32			



# TEBAS

## COUNTERTOP WASHBASINS



### FEATURES / CARATTERISTICHE

Countertop washbasin  
No overflow.  
White porcelain.

Lavandino da appoggio.  
Senza sfioratore.  
Porcellana bianca.



### TECHNICAL INFORMATION / INFORMAZIONI TECNICHE

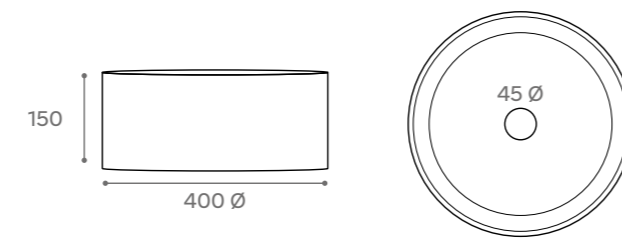

### CODING / CODIFICA

MODEL MODELLO	CODE CODICE	REFERENCE RIFERIMENTO
TEBAS	30.86.277	LAV.TEBAS

# ROUND MINI

## COUNTERTOP WASHBASINS



### FEATURES / CARATTERISTICHE

Countertop washbasin  
With overflow.  
With faucet hole.  
White porcelain.

Lavandino da appoggio.  
Con sfioratore.  
Con foro per rubinetto.  
Porcellana bianca.



### TECHNICAL INFORMATION / INFORMAZIONI TECNICHE

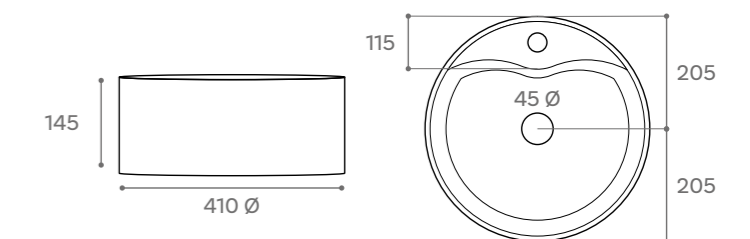

### CODING / CODIFICA

MODEL MODELLO	CODE CODICE	REFERENCE RIFERIMENTO
ROUND MINI	30.89.277	LAV.ROUND.M

# AURE

## COUNTERTOP WASHBASINS



### FEATURES / CARATTERISTICHE

Countertop washbasin  
No overflow.  
White porcelain.

Lavandino da appoggio.  
Senza sfioratore.  
Porcellana bianca.



### TECHNICAL INFORMATION / INFORMAZIONI TECNICHE

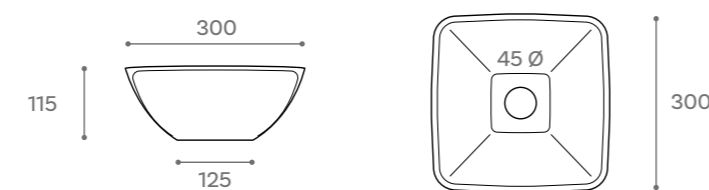

### CODING / CODIFICA

MODEL MODELLO	CODE CODICE	REFERENCE RIFERIMENTO
AURE	30.85.277	LAV.AURE

# OVAL

## COUNTERTOP WASHBASINS



### FEATURES / CARATTERISTICHE

Countertop washbasin  
No overflow.  
White porcelain.

Lavandino da appoggio.  
Senza sfioratore.  
Porcellana bianca.



### TECHNICAL INFORMATION / INFORMAZIONI TECNICHE

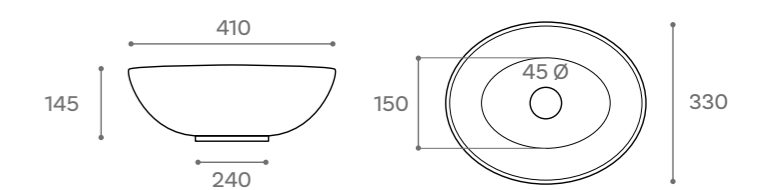

### CODING / CODIFICA

MODEL MODELLO	CODE CODICE	REFERENCE RIFERIMENTO
OVAL	30.86.277	LAV.OVAL

# LEO

## COUNTERTOP WASHBASINS



### FEATURES / CARATTERISTICHE

Countertop washbasin  
With overflow.  
With faucet hole.  
White porcelain.

*Lavandino da appoggio.  
Con sfioratore.  
Con foro per rubinetno.  
Porcellana bianca.*



### TECHNICAL INFORMATION / INFORMAZIONI TECNICHE

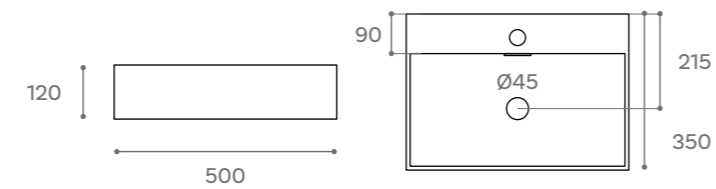

### CODING / CODIFICA

MODEL MODELLO	CODE CODICE	REFERENCE RIFERIMENTO
LEO	30.111.277	LAV.LEO

# LIBRA

## COUNTERTOP WASHBASINS



### FEATURES / CARATTERISTICHE

Countertop washbasin  
With overflow.  
With faucet hole.  
White porcelain.

*Lavandino da appoggio.  
Con sfioratore.  
Con foro per rubinetto.  
Porcellana bianca.*



### TECHNICAL INFORMATION / INFORMAZIONI TECNICHE

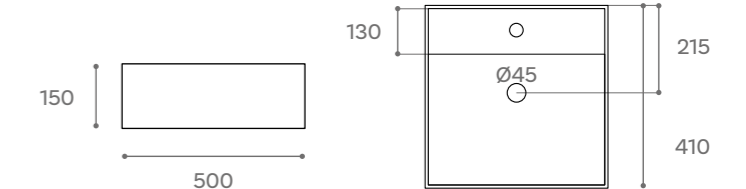

### CODING / CODIFICA

MODEL MODELLO	CODE CODICE	REFERENCE RIFERIMENTO
LIBRA	30.89.277	LAV.LIBRA

# SAJA

## COUNTERTOP WASHBASINS



### FEATURES / CARATTERISTICHE

Countertop washbasin  
No overflow.  
White porcelain.

*Lavandino da appoggio.  
Senza sfioratore.  
Porcellana bianca.*



### TECHNICAL INFORMATION / INFORMAZIONI TECNICHE

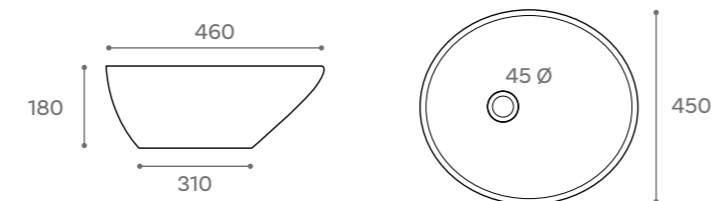

### CODING / CODIFICA

MODEL MODELLO	CODE CODICE	REFERENCE RIFERIMENTO
SAJA	30.120.277	LAV.SAJA

# MENFIS

## COUNTERTOP WASHBASINS



### FEATURES / CARATTERISTICHE

Countertop washbasin  
With overflow.  
White porcelain.

*Lavandino da appoggio.  
Con sfioratore.  
Porcellana bianca.*



### TECHNICAL INFORMATION / INFORMAZIONI TECNICHE

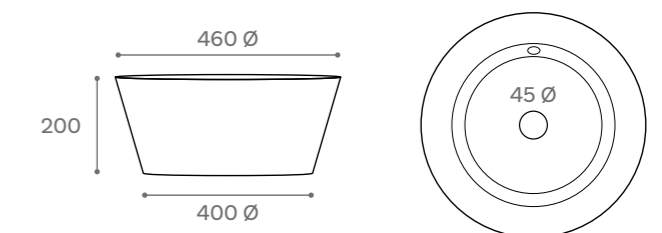

### CODING / CODIFICA

MODEL MODELLO	CODE CODICE	REFERENCE RIFERIMENTO
MENFIS	30.116.277	LAV.MENFIS

# GEMINI 75

## COUNTERTOP WASHBASINS



### FEATURES / CARATTERISTICHE

Countertop washbasin  
With overflow.  
With faucet hole.  
White porcelain.

*Lavandino da appoggio.  
Con sfioratore.  
Con foro per rubinetto.  
Porcellana bianca.*

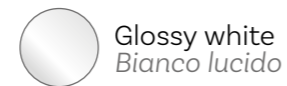

### TECHNICAL INFORMATION / INFORMAZIONI TECNICHE

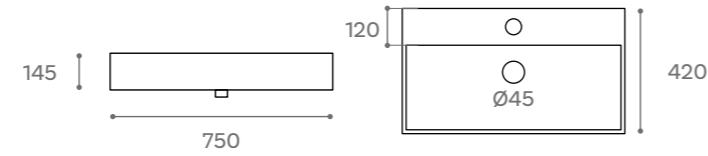

### CODING / CODIFICA

MODEL MODELLO	CODE CODICE	REFERENCE RIFERIMENTO
GEMINI	30.235.277	LAV-GEMINI

# YELTES

## COUNTERTOP WASHBASINS



### FEATURES / CARATTERISTICHE

Countertop washbasin  
No overflow.  
With faucet hole.  
White porcelain.

*Lavandino da appoggio.  
Senza sfioratore.  
Con foro per rubinetto.  
Porcellana bianca.*



### TECHNICAL INFORMATION / INFORMAZIONI TECNICHE

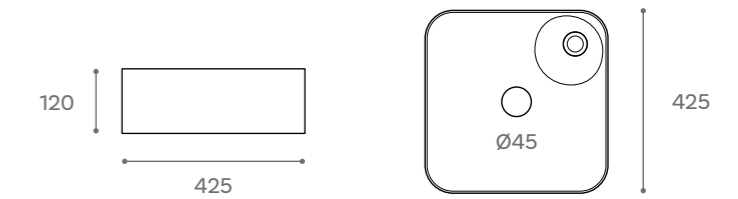

### CODING / CODIFICA

MODEL MODELLO	CODE CODICE	REFERENCE RIFERIMENTO
YELTES	30.108.277	LAV.YELTES

# BEIRA

## COUNTERTOP WASHBASINS



### FEATURES / CARATTERISTICHE

Countertop washbasin  
No overflow.  
White porcelain.

*Lavandino da appoggio.  
Senza sfioratore.  
Porcellana bianca.*

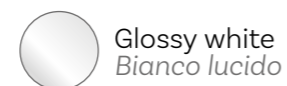

### TECHNICAL INFORMATION / INFORMAZIONI TECNICHE

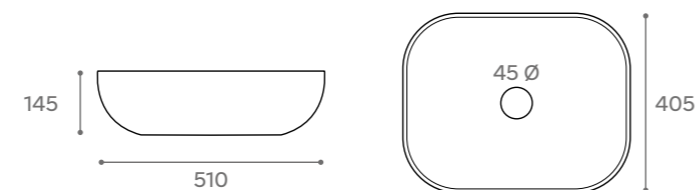

### CODING / CODIFICA

MODEL MODELLO	CODE CODICE	REFERENCE RIFERIMENTO
BEIRA	30.135.277	LAV.BEIRA

# ANUBIS

## COUNTERTOP WASHBASINS



### FEATURES / CARATTERISTICHE

Countertop washbasin  
No overflow.  
White porcelain.

*Lavandino da appoggio.  
Senza sfioratore.  
Porcellana bianca.*



### TECHNICAL INFORMATION / INFORMAZIONI TECNICHE

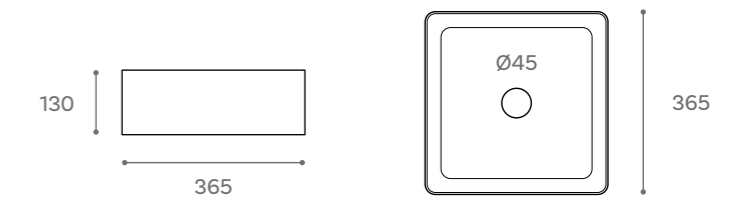

### CODING / CODIFICA

MODEL MODELLO	CODE CODICE	REFERENCE RIFERIMENTO
ANUBIS	30.101.277	LAV.ANUBI



Fogo matte white



Fogo glossy white



Fogo matte black

### FEATURES / CARATTERISTICHE



Countertop washbasin  
No overflow.

*Lavandino da appoggio.  
Senza sfioratore.*

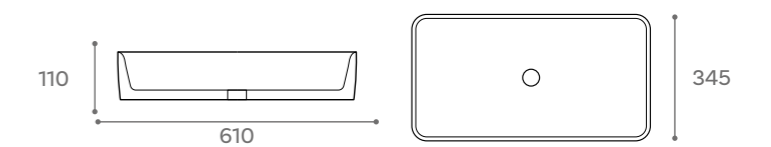
### TECHNICAL INFORMATION / INFORMAZIONI TECNICHE



### FINISHING / FINITURA

-  Matte white  
Bianco opaco
-  Matte black  
Nero opaco
-  Glossy white  
Bianco lucido

### OPTIONAL VALVES / VALVOLE OPZIONALI

-  Glossy white  
Bianco lucido
-  Matte white  
Bianco opaco
-  Matte black  
Nero opaco

### CODING / CODIFICA

MODELLO	CODE	REFERIMENTO	MODELLO	CODE	REFERIMENTO
FOGO MATTE WHITE	30.193.277	LAV.FOGO	GLOSSY WHITE VALVE	30.19.277	VALUNI.L.P
FOGO MATTE BLACK	30.193.277	LAV.FOGON	MATTE WHITE VALVE	30.24.277	VALUNI.BMC
FOGO GLOSSY WHITE	30.130.277	LAV.FOGOBR	MATTE BLACK VALVE	30.24.277	VALUNI.NMC

# CATAY

## COUNTERTOP WASHBASINS



### FEATURES / CARATTERISTICHE

Countertop washbasin  
No overflow.  
White porcelain.

*Lavandino da appoggio.  
Senza sfioratore.  
Porcellana bianca.*

### FINISHING / FINITURA

 Glossy white  
Bianco lucido

### CODING / CODIFICA

MODEL MODELLO	CODE CODICE	REFERENCE RIFERIMENTO
CATAY	30.155.277	LAV.CATAY

### TECHNICAL INFORMATION / INFORMAZIONI TECNICHE

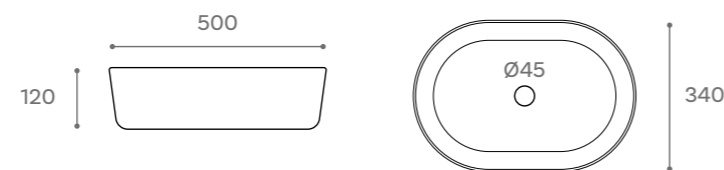

# AMUR

## COUNTERTOP WASHBASINS



### FEATURES / CARATTERISTICHE

Countertop washbasin  
No overflow.  
White porcelain.

*Lavandino da appoggio.  
Senza sfioratore.  
Porcellana bianca.*

 Glossy white  
Bianco lucido

### TECHNICAL INFORMATION / INFORMAZIONI TECNICHE

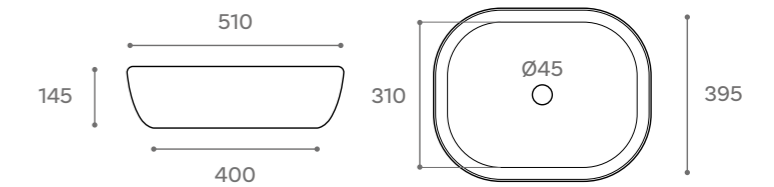

### CODING / CODIFICA

MODEL MODELLO	CODE CODICE	REFERENCE RIFERIMENTO
AMUR	30.105.277	LAV.AMUR

# IRIS

## COUNTERTOP WASHBASINS



### FEATURES / CARATTERISTICHE

Countertop washbasin  
No overflow.  
White porcelain.

*Lavandino da appoggio.  
Senza sfioratore.  
Porcellana bianca.*

 Glossy white  
Bianco lucido

### TECHNICAL INFORMATION / INFORMAZIONI TECNICHE

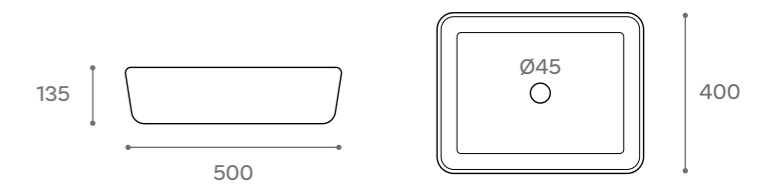

### CODING / CODIFICA

MODEL MODELLO	CODE CODICE	REFERENCE RIFERIMENTO
IRIS	30.128.277	LAV.ISIS



Horus matte white



Horus glossy white





Horus matte black

### FEATURES / CARATTERISTICHE

Countertop washbasin  
No overflow.  
Porcelain.

*Lavandino da appoggio.  
Senza sfioratore.  
Porcellana.*

### FINISHING / FINITURA

-  Matte white  
Bianco opaco
-  Matte black  
Nero opaco
-  Glossy white  
Bianco lucido

### CODING / CODIFICA

MODEL MODELLO	CODE CODICE	REFERENCE RIFERIMENTO	MODEL MODELLO	CODE CODICE	REFERENCE RIFERIMENTO
HORUS MATTE WHITE	30.182.277	LAV.HORUSB	GLOSSY WHITE VALVE	30.19.277	VALUNI.L.P
HORUS MATTE BLACK	30.182.277	LAV.HORUSN	MATTE WHITE VALVE	30.24.277	VALUNI.BMC
HORUS GLOSSY WHITE	30.93.277	LAV.HORUS	MATTE BLACK VALVE	30.24.277	VALUNI.NMC

### TECHNICAL INFORMATION / INFORMAZIONI TECNICHE

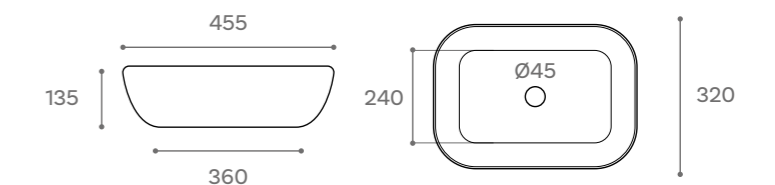

### OPTIONAL VALVES / VALVOLE OPZIONALI

-  Glossy white  
Bianco lucido
-  Matte white  
Bianco opaco
-  Matte black  
Nero opaco



### FEATURES / CARATTERISTICHE

Countertop washbasin  
No overflow.  
Porcelain.

Lavandino da appoggio.  
Senza sfioratore.  
Porcellana.

### FINISHING / FINITURA

-  Glossy white  
*Bianco lucido*
-  Matte black  
*Noir mat*
-  Matte white  
*Bianco opaco*
-  Deep gray  
*Grigio scuro*
-  Matte camel  
*Cammello opaco*

### CODING / CODIFICA

MODEL MODELLO	CODE CODICE	REFERENCE RIFERIMENTO	MODEL MODELLO	CODE CODICE	REFERENCE RIFERIMENTO
OSIRIS GLOSSY WHITE	30.105.277	LOBB35X35X12	OSIRIS MATTE CAMEL	30.198.277	LOC35X35X12
OSIRIS MATTE WHITE	30.171.277	LOB35X35X12	GLOSSY WHITE VALVE	30.19.277	VALUNI.L.P
OSIRIS MATTE BLACK	30.184.277	LON35X35X12	MATTE WHITE VALVE	30.24.277	VALUNI.BMC
OSIRIS MATTE DEEP GRAY	30.198.277	LOGO35X35X12	MATTE BLACK VALVE	30.24.277	VALUNI.NMC

### TECHNICAL INFORMATION / INFORMAZIONI TECNICHE

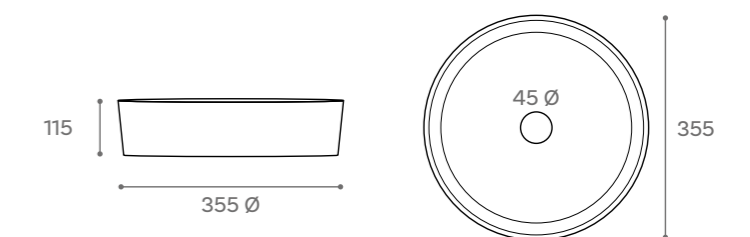

### OPTIONAL VALVES / VALVOLE OPZIONALI





Satet matte white



Satet glossy white



Satet matte black

### FEATURES / CARATTERISTICHE

Countertop washbasin  
No overflow.  
Porcelain.

*Lavandino da appoggio.  
Senza sfioratore.  
Porcellana.*

### FINISHING / FINITURA

- 

Matte white  
Bianco opaco
- 

Matte black  
Nero opaco
- 

Glossy white  
Bianco lucido

### CODING / CODIFICA

MODEL MODELLO	CODE CODICE	REFERENCE RIFERIMENTO	MODEL MODELLO	CODE CODICE	REFERENCE RIFERIMENTO
SATET MATTE WHITE	30.161.277	LSB36X36X11,50	GLOSSY WHITE VALVE	30.19.277	VALUNI.L.P
SATET MATTE BLACK	30.171.277	LSN36X36X11,50	MATTE WHITE VALVE	30.24.277	VALUNI.BMC
SATET GLOSSY WHITE	30.102.277	LAV.SATETBB	MATTE BLACK VALVE	30.24.277	VALUNI.NMC

### TECHNICAL INFORMATION / INFORMAZIONI TECNICHE

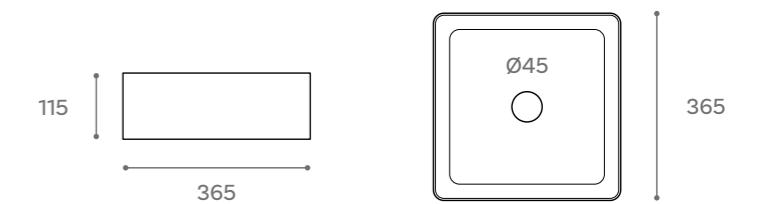

### OPTIONAL VALVES / VALVOLE OPZIONALI

- 

Glossy white  
Bianco lucido
- 

Matte white  
Bianco opaco
- 

Matte black  
Nero opaco



# AJAX

## COUNTERTOP WASHBASINS



### FEATURES / CARATTERISTICHE

Countertop washbasin  
No overflow.  
White porcelain.

*Lavandino da appoggio.  
Senza sfioratore.  
Porcellana bianca.*

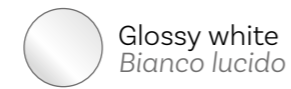

### TECHNICAL INFORMATION / INFORMAZIONI TECNICHE

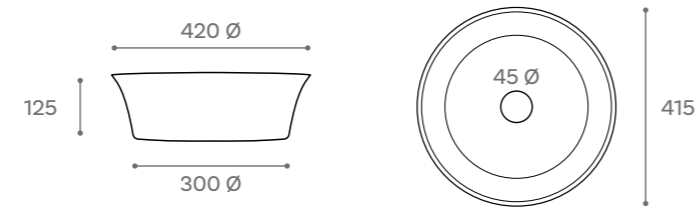

### CODING / CODIFICA

MODEL MODELLO	CODE CODICE	REFERENCE RIFERIMENTO
AJAX	30.96.277	LAV.AJAX

# AGNES

## COUNTERTOP WASHBASINS



### FEATURES / CARATTERISTICHE

Countertop washbasin  
No overflow.  
White porcelain.

*Lavandino da appoggio.  
Senza sfioratore.  
Porcellana bianca.*

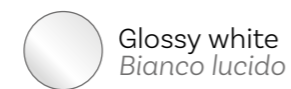

### TECHNICAL INFORMATION / INFORMAZIONI TECNICHE

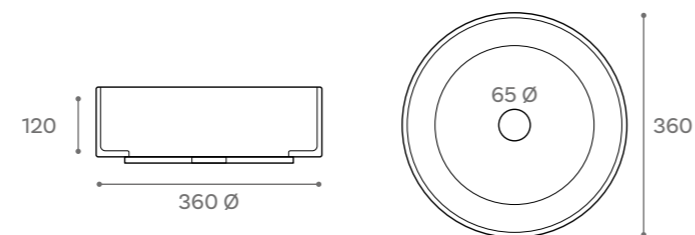

### CODING / CODIFICA

MODEL MODELLO	CODE CODICE	REFERENCE RIFERIMENTO
AGNES	30.125.277	LAV.AGNES

SHOP  
THE LOOK



Krion® mirror (available under quotation)  
Firenze washbasin page 137  
Krion® board with skirt page 32  
Matte black siphon page 166  
Krion® bench page 33  
Deba bathtub page 58

# PIETRO

## COUNTERTOP WASHBASINS



### FEATURES CARATTERISTICHE

Floor-standing washbasin.  
With overflow.  
With faucet hole.  
White porcelain.

*Lavandino con colonna.  
Con sfioratore.  
Con foro per rubinetto.  
Porcellana bianca.*

### FINISHING FINITURA

 Glossy white  
Bianco lucido

### TECHNICAL INFORMATION INFORMAZIONI TECNICHE

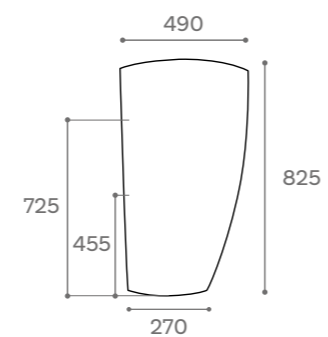
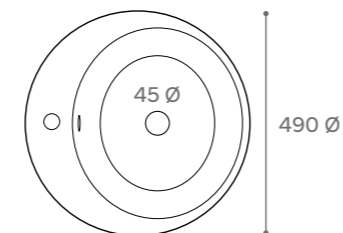

### CODING CODIFICA

MODEL MODELLO	CODE CODICE	REFERENCE RIFERIMENTO
PIETRO	30.631.277	LAV.PIET

# NOA

## COUNTERTOP WASHBASINS



### FEATURES CARATTERISTICHE

Floor-standing washbasin.  
No overflow.  
White porcelain.

*Lavandino con colonna.  
Senza sfioratore.  
Porcellana bianca.*

### FINISHING FINITURA

 Glossy white  
Bianco lucido

### TECHNICAL INFORMATION INFORMAZIONI TECNICHE

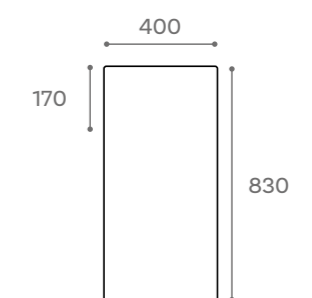
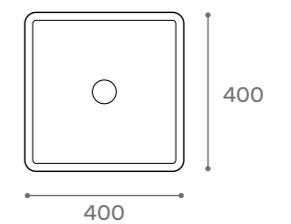

### CODING CODIFICA

MODEL MODELLO	CODE CODICE	REFERENCE RIFERIMENTO
NOA	30.580.277	LAV.NOA

WASHBASINS

*LAVANDINI SOSPESI*

**WALL-HUNG**

## WALL-HUNG WASHBASINS

Within the family of ceramic washbasins, Art & Bath offers its range of wall-hung washbasins, also known as wall-mounted washbasins or wall washbasins, which are the ideal solution for small bathrooms or configurations that do not require storage, such as guest toilets. These washbasins allow for space-saving and minimalist yet functional environments. We are sure you will find the solution you need in our wide range of wall hung washbasins.

## LAVANDINI SOSPESI

All'interno della famiglia dei lavandini in ceramica, Art & Bath offre la sua gamma di lavandini sospesi, noti anche come lavandini a muro o lavandini a parete, che rappresentano la soluzione ideale per i bagni di piccole dimensioni o per le configurazioni che non richiedono spazio di immagazzinaggio, come ad esempio le toilette di cortesia...Questi lavandini ci consentono di risparmiare spazio e di creare ambienti minimalisti ma funzionali. Nella nostra ampia gamma di lavandini sospesi troverete sicuramente la soluzione di cui avete bisogno.

# GORDON

## WALL-HUNG WASHBASINS



### FEATURES / CARATTERISTICHE

Wall-hung washbasin.  
With overflow.  
With faucet hole.  
Screws included.  
White porcelain.

*Lavandino sospeso  
Con sfioratore.  
Con foro per rubinetto.  
Viteria inclusa.  
Porcellana bianca.*

### FINISHING / FINITURA

 Glossy white  
Bianco lucido

### CODING / CODIFICA

MODEL MODELLO	CODE CODICE	REFERENCE RIFERIMENTO
GORDON	30.350.277	LAV. GORDON

### TECHNICAL INFORMATION / INFORMAZIONI TECNICHE

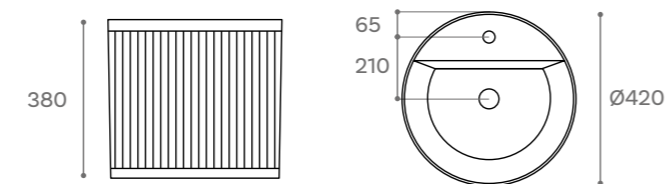

# PICCOLO

## WALL-HUNG WASHBASINS



### FEATURES / CARATTERISTICHE

No overflow.  
With faucet hole.  
Screws included.  
White porcelain.

*Senza sfioratore.  
Con foro per rubinetto.  
Viteria inclusa.  
Porcellana bianca.*

 Glossy white  
Bianco lucido

### TECHNICAL INFORMATION / INFORMAZIONI TECNICHE

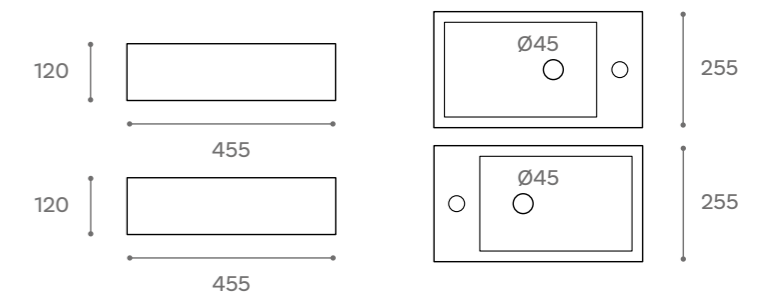

### CODING / CODIFICA

MODEL MODELLO	CODE CODICE	REFERENCE RIFERIMENTO
PICCOLO RIGHT	30.108.277	LAV.PIC.45X25
PICCOLO LEFT	30.108.277	LAV.PIC.45X25I

# LIBRA

## WALL-HUNG WASHBASINS



### FEATURES / CARATTERISTICHE

With overflow.  
With faucet hole.  
Screws not included.  
White porcelain.

*Con sfioratore.  
Con foro per rubinetto.  
Viteria non inclusa.  
Porcellana bianca.*

 Glossy white  
Bianco lucido

### TECHNICAL INFORMATION / INFORMAZIONI TECNICHE

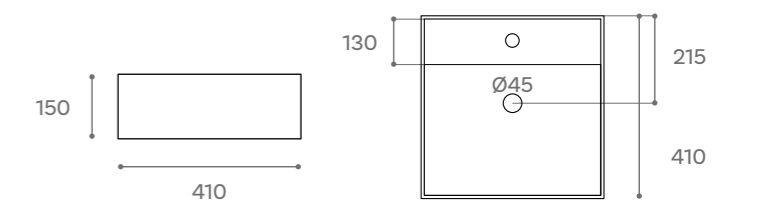

### CODING / CODIFICA

MODEL MODELLO	CODE CODICE	REFERENCE RIFERIMENTO
LIBRA	30.89.277	LAV.LIBRA
Fixing set	30.14.277	TLI

# SIL

## WALL-HUNG WASHBASINS



### FEATURES / CARATTERISTICHE

With overflow.  
With faucet hole.  
Screws not included.  
White porcelain.

Con sfioratore.  
Con foro per rubinetto.  
Viteria non inclusa.  
Porcellana bianca.

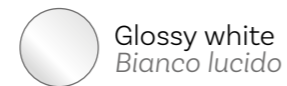

### TECHNICAL INFORMATION / INFORMAZIONI TECNICHE

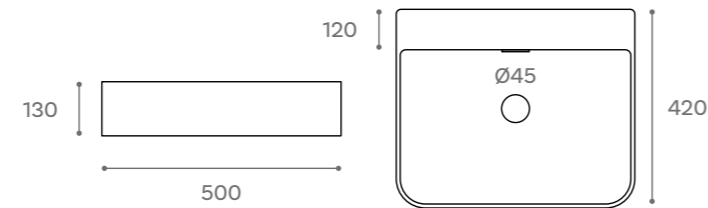

### CODING / CODIFICA

MODEL MODELLO	CODE CODICE	REFERENCE RIFERIMENTO
SIL	03.0151.277	LAV.SIL
Fixing set	03.014.277	

# GEMINI

## WALL-HUNG WASHBASINS



### FEATURES / CARATTERISTICHE

With overflow.  
With faucet hole.  
Screws not included.  
White porcelain.

Con sfioratore.  
Con foro per rubinetto.  
Viteria non inclusa.  
Porcellana bianca.

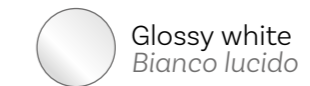

### TECHNICAL INFORMATION / INFORMAZIONI TECNICHE

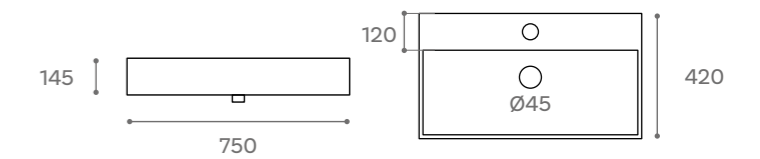

### CODING / CODIFICA

MODEL MODELLO	CODE CODICE	REFERENCE RIFERIMENTO
GEMINI	03.0235.277	LAV-GEMINI
Fixing set	03.014.277	

# EUME

## WALL-HUNG WASHBASINS



### FEATURES / CARATTERISTICHE

With overflow.  
With faucet hole.  
Screws not included.  
White porcelain.

Con sfioratore.  
Con foro per rubinetto.  
Viteria non inclusa.  
Porcellana bianca.

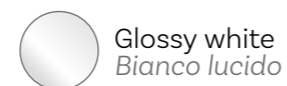

### TECHNICAL INFORMATION / INFORMAZIONI TECNICHE

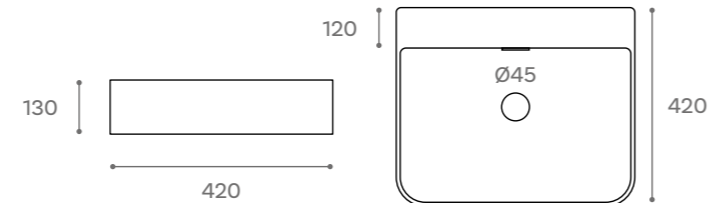

### CODING / CODIFICA

MODEL MODELLO	CODE CODICE	REFERENCE RIFERIMENTO
EUME	03.0130.277	LAV.EUME
Fixing set	03.014.277	

# LEO

## WALL-HUNG WASHBASINS



### FEATURES / CARATTERISTICHE

With overflow.  
With faucet hole.  
Screws not included.  
White porcelain.

Con sfioratore.  
Con foro per rubinetto.  
Viteria non inclusa.  
Porcellana bianca.



### TECHNICAL INFORMATION / INFORMAZIONI TECNICHE

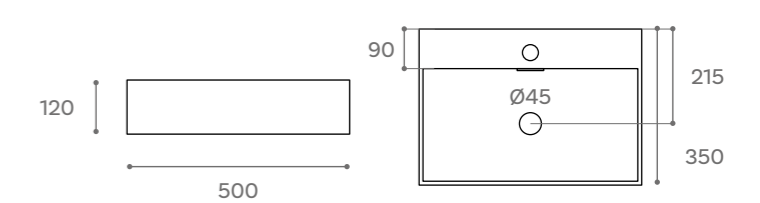

### CODING / CODIFICA

MODEL MODELLO	CODE CODICE	REFERENCE RIFERIMENTO
LEO	03.0111.277	LAV.LEO
Fixing set	03.014.277	

# ADONIA

## WALL-HUNG WASHBASINS



### FEATURES / CARATTERISTICHE

No overflow.  
With faucet hole.  
Screws included.  
White porcelain.

Senza sfioratore.  
Con foro per rubinetto.  
Viteria inclusa.  
Porcellana bianca.



### TECHNICAL INFORMATION / INFORMAZIONI TECNICHE

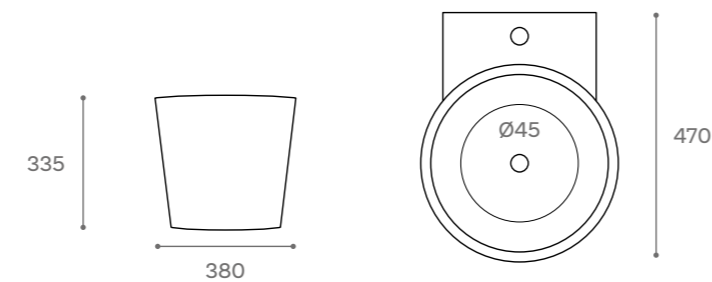

### CODING / CODIFICA

MODEL MODELLO	CODE CODICE	REFERENCE RIFERIMENTO
ADONIA	30.211.277	LAV.ADO

# BEMUS

## WALL-HUNG WASHBASINS



### FEATURES / CARATTERISTICHE

No overflow.  
With faucet hole.  
Screws included.  
White porcelain.

Senza sfioratore.  
Con foro per rubinetto.  
Viteria inclusa.  
Porcellana bianca.

### FINISHING / FINITURA



### TECHNICAL INFORMATION / INFORMAZIONI TECNICHE

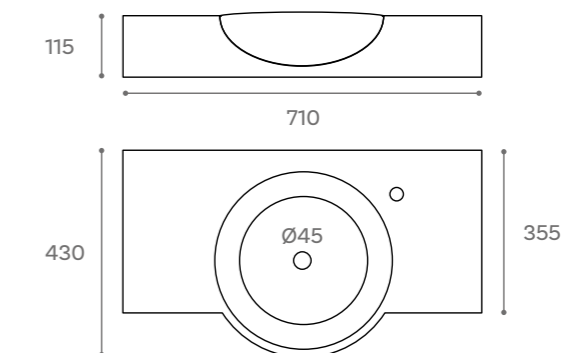

### CODING / CODIFICA

MODEL MODELLO	CODE CODICE	REFERENCE RIFERIMENTO
BEMUS	30.235.277	LAV.BEM

# DASHA

## WALL-HUNG WASHBASINS



### FEATURES / CARATTERISTICHE

With overflow.  
With faucet hole.  
Screws included.  
White porcelain.

Con sfioratore.  
Con foro per rubinetto.  
Viteria inclusa.  
Porcellana bianca.

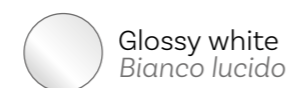

### TECHNICAL INFORMATION / INFORMAZIONI TECNICHE

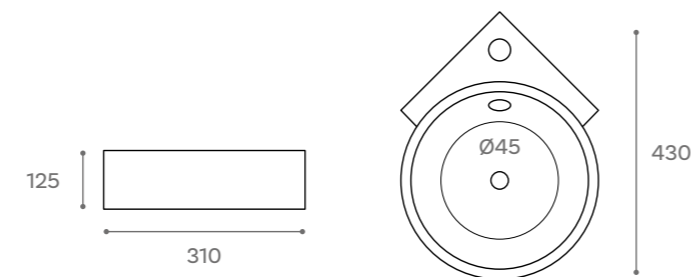

### CODING / CODIFICA

MODEL MODELLO	CODE CODICE	REFERENCE RIFERIMENTO
DASHA	30.95.277	LAV.DASHA

WASHBASINS

*LAVANDINI DECORATIVI*

**DECORATIVE**



## DECORATIVE WASHBASINS

The washbasin has become the centerpiece of the bathroom. Its many decorative options and formats respond to the different interior design styles that have been developed over the last few years. Adaptable to all types of spaces, Art & Bath's washbasins have a wide variety of finishes. They create from the most avant-garde to the most elegant ambiances, reinforced by their spectacular finishes, without leaving behind the Mediterranean essence that inspires the brand so much.

## LAVANDINI DECORATIVI

*Il lavandino è diventato l'elemento centrale del bagno. Le sue molteplici opzioni decorativi e formati rispondono ai diversi stili di interior design sviluppati negli ultimi anni. Adattabili a tutti i tipi di spazi, i lavabi Art & Bath offrono un'ampia varietà di finiture, creando dagli ambienti più all'avanguardia a quelli più eleganti, valorizzati dalle loro splendide finiture, senza dimenticare l'essenza mediterranea che è una grande fonte di ispirazione del marchio.*

# TERRAZO

## DECORATIVE WASHBASINS



Terrazzo matte gray



Terrazzo matte beige

### FEATURES / CARATTERISTICHE

Countertop washbasin  
No overflow.  
Terrazzo.

*Lavandino da appoggio.  
Senza sfioratore.  
Terrazzo.*

### FINISHING / FINITURA



### CODING / CODIFICA

MODEL MODELLO	CODE CODICE	REFERENCE RIFERIMENTO
TERRAZO GRAY	30.246.277	LAV.TERRAG
TERRAZO BEIGE	30.246.277	LAV.TERRAB

### TECHNICAL INFORMATION / INFORMAZIONI TECNICHE

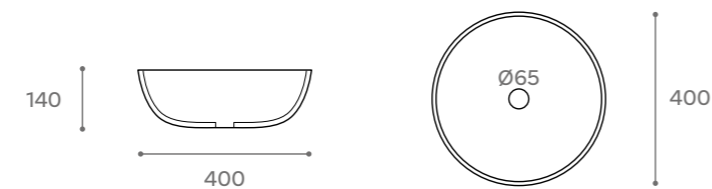

# COPER

## DECORATIVE WASHBASINS



### FEATURES / CARATTERISTICHE

Countertop washbasin  
No overflow.  
Porcelain.

*Lavandino da appoggio.  
Senza sfioratore.  
Porcellana.*



### TECHNICAL INFORMATION / INFORMAZIONI TECNICHE

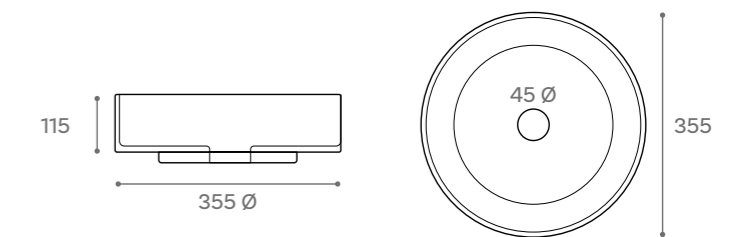

### CODING / CODIFICA

MODEL MODELLO	CODE CODICE	REFERENCE RIFERIMENTO
COPER	30.160.277	LAV.COPER
VALVE	30.34.277	VALUNI.CP

# PRAGA

## DECORATIVE WASHBASINS



### FEATURES / CARATTERISTICHE

Countertop washbasin  
No overflow.  
Porcelain.

*Lavandino da appoggio.  
Senza sfioratore.  
Porcellana.*



### TECHNICAL INFORMATION / INFORMAZIONI TECNICHE

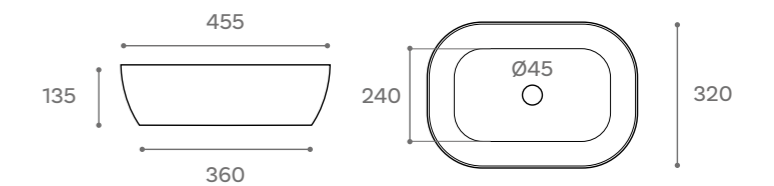

### CODING / CODIFICA

MODEL MODELLO	CODE CODICE	REFERENCE RIFERIMENTO
PRAGA	30.180.277	LAV.PRAGA
VALVE	30.34.277	VALUNI.TP

# KARIBA

## DECORATIVE WASHBASINS



### FEATURES / CARATTERISTICHE

Countertop washbasin  
No overflow.  
Made of cement.

*Lavandino da appoggio.  
Senza sfioratore.  
Realizzato in cemento.*



### TECHNICAL INFORMATION / INFORMAZIONI TECNICHE

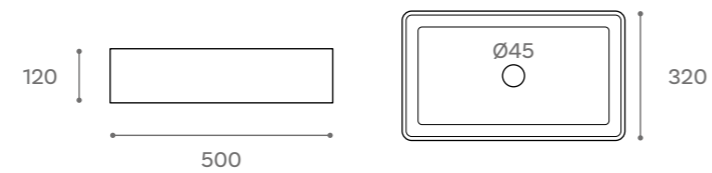

### CODING / CODIFICA

MODEL MODELLO	CODE CODICE	REFERENCE RIFERIMENTO
KARIBA	30.251.277	LAV.KARIBA

# DIPINTO

## DECORATIVE WASHBASINS



### FEATURES / CARATTERISTICHE

Countertop washbasin  
No overflow.  
Porcelain.

*Lavandino da appoggio.  
Senza sfioratore.  
Porcellana.*



### TECHNICAL INFORMATION / INFORMAZIONI TECNICHE

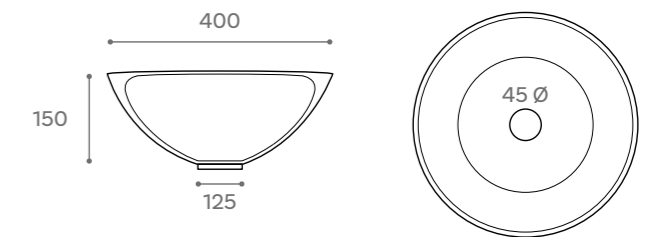

### CODING / CODIFICA

MODEL MODELLO	CODE CODICE	REFERENCE RIFERIMENTO
DIPINTO	30.158.277	LAV.DIPINTO
VALVE	30.34.277	VALUNI.TB2

# SFERA

## DECORATIVE WASHBASINS



### FEATURES / CARATTERISTICHE

Countertop washbasin  
No overflow.  
Made of cement.

*Lavandino da appoggio.  
Senza sfioratore.  
Realizzato in cemento.*



### TECHNICAL INFORMATION / INFORMAZIONI TECNICHE

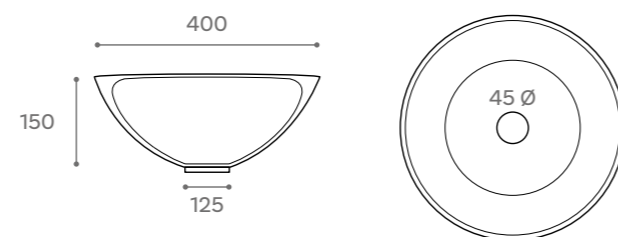

### CODING / CODIFICA

MODEL MODELLO	CODE CODICE	REFERENCE RIFERIMENTO
SFERA	30.251.277	LAV.SFERA

# BELICE

## DECORATIVE WASHBASINS



### FEATURES / CARATTERISTICHE

Countertop washbasin  
No overflow.  
Porcelain.

*Lavandino da appoggio.  
Senza sfioratore.  
Porcellana.*



### TECHNICAL INFORMATION / INFORMAZIONI TECNICHE

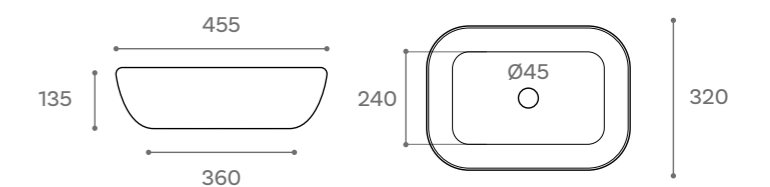

### CODING / CODIFICA

MODEL MODELLO	CODE CODICE	REFERENCE RIFERIMENTO
BELICE	30.158.277	LAV.BELICE
VALVE	30.34.277	VALUNI.TB2



### FEATURES / CARATTERISTICHE

Countertop washbasin  
No overflow.  
Porcelain.

*Lavandino da appoggio.  
Senza sfioratore.  
Porcellana.*

### FINISHING / FINITURA

 Black marble  
Marmo nero.

### CODING / CODIFICA

MODEL MODELLO	CODE CODICE	REFERENCE RIFERIMENTO
ISEO	30.146.277	LAV.ISEO
VALVE	30.34.277	VALUNI.TN

### TECHNICAL INFORMATION / INFORMAZIONI TECNICHE

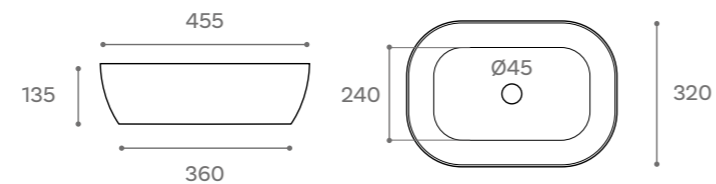

Matching valve  
Valvola abbinata

\*Drawings may vary from one model to another.  
\*È possibile che i disegni varino da un modello all'altro.



### FEATURES / CARATTERISTICHE

Countertop washbasin  
No overflow.  
Porcelain.

*Lavandino da appoggio.  
Senza sfioratore.  
Porcellana.*

 Black marble  
Marmo nero.

 Matching valve  
Valvola abbinata

### TECHNICAL INFORMATION / INFORMAZIONI TECNICHE

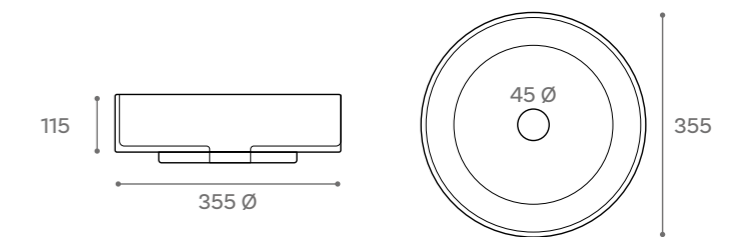

### CODING / CODIFICA

MODEL MODELLO	CODE CODICE	REFERENCE RIFERIMENTO
COMO	30.154.277	LAV.COMO
VALVE	30.34.277	VALUNI.TN

\*Drawings may vary from one model to another.  
\*È possibile che i disegni varino da un modello all'altro.



### FEATURES / CARATTERISTICHE

Countertop washbasin  
No overflow.  
Porcelain.

*Lavandino da appoggio.  
Senza sfioratore.  
Porcellana.*

 Black marble  
Marmo nero.

 Matching valve  
Valvola abbinata

### TECHNICAL INFORMATION / INFORMAZIONI TECNICHE

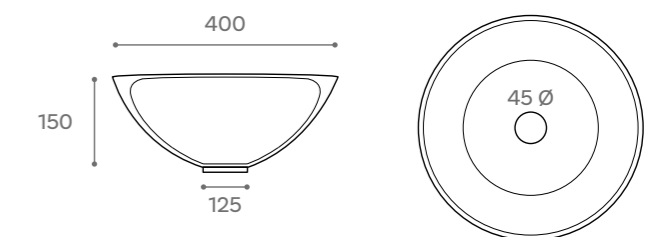

### CODING / CODIFICA

MODEL MODELLO	CODE CODICE	REFERENCE RIFERIMENTO
GÉNOVA	30.158.277	LAV.GÉNOVA
VALVE	30.34.277	VALUNI.TN

\*Drawings may vary from one model to another.  
\*È possibile che i disegni varino da un modello all'altro.

# ORTA

## DECORATIVE WASHBASINS



### FEATURES / CARATTERISTICHE

Countertop washbasin  
No overflow.  
Porcelain.

*Lavandino da appoggio.  
Senza sfioratore.  
Porcellana.*

### FINISHING / FINITURA

 White marble  
Marmo bianco

### CODING / CODIFICA

MODEL MODELLO	CODE CODICE	REFERENCE RIFERIMENTO
ORTA	30.146.277	LAV.ORTA
VALVE	30.34.277	VALUNI.TB

### TECHNICAL INFORMATION / INFORMAZIONI TECNICHE

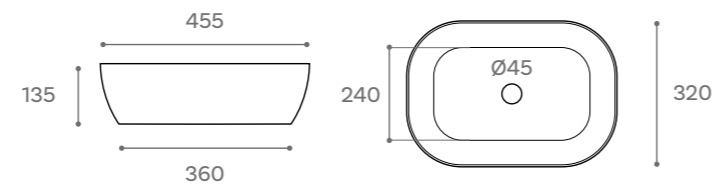

Matching valve  
Valvola abbinata

\*Drawings may vary from one model to another.  
\*È possibile che i disegni varino da un modello all'altro.

# GARDA

## DECORATIVE WASHBASINS



### FEATURES / CARATTERISTICHE

Countertop washbasin  
No overflow.  
Porcelain.

*Lavandino da appoggio.  
Senza sfioratore.  
Porcellana.*

 White marble  
Marmo bianco

 Matching valve  
Valvola abbinata

### TECHNICAL INFORMATION / INFORMAZIONI TECNICHE

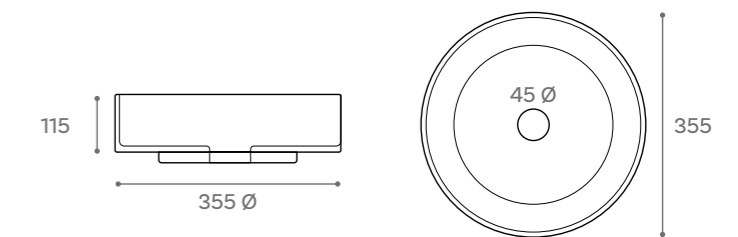

### CODING / CODIFICA

MODEL MODELLO	CODE CODICE	REFERENCE RIFERIMENTO
GARDA	30.154.277	LAV.GARDA
VALVE	30.34.277	VALUNI.TB

\*Drawings may vary from one model to another.  
\*È possibile che i disegni varino da un modello all'altro.

# FIRENZE

## DECORATIVE WASHBASINS



### FEATURES / CARATTERISTICHE

Countertop washbasin  
No overflow.  
Porcelain.

*Lavandino da appoggio.  
Senza sfioratore.  
Porcellana.*

 White marble  
Marmo bianco

 Matching valve  
Valvola abbinata

### TECHNICAL INFORMATION / INFORMAZIONI TECNICHE

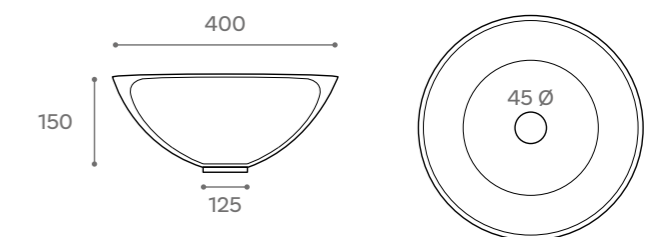

### CODING / CODIFICA

MODEL MODELLO	CODE CODICE	REFERENCE RIFERIMENTO
FIRENZE	30.158.277	LAV.FIRENZE
VALVE	30.34.277	VALUNI.TB

\*Drawings may vary from one model to another.  
\*È possibile che i disegni varino da un modello all'altro.

# GIZA

## DECORATIVE WASHBASINS



### FEATURES / CARATTERISTICHE

Countertop washbasin  
No overflow.  
Porcelain.

*Lavandino da appoggio.  
Senza sfioratore.  
Porcellana.*

### FINISHING / FINITURA

 Black marble  
Marmo nero

### CODING / CODIFICA

MODEL MODELLO	CODE CODICE	REFERENCE RIFERIMENTO
GIZA	30.158.277	LAV.GIZA
VALVE	30.34.277	VALUNI.GZ

### TECHNICAL INFORMATION / INFORMAZIONI TECNICHE

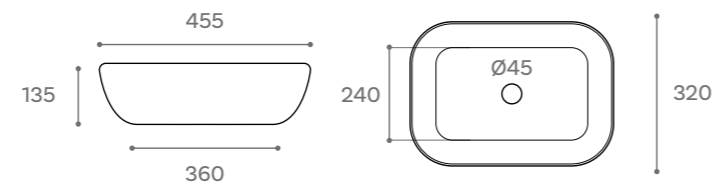

Matching valve  
Valvola abbinata

\*Drawings may vary from one model to another.  
\*È possibile che i disegni varino da un modello all'altro.

# BOL BICOLOR

## DECORATIVE WASHBASINS



### FEATURES / CARATTERISTICHE

Countertop washbasin  
No overflow.  
2 color porcelain.

*Lavandino da appoggio.  
Senza sfioratore.  
Porcellana in 2 colori.*

 Silver / white  
Argento / bianco

### TECHNICAL INFORMATION / INFORMAZIONI TECNICHE

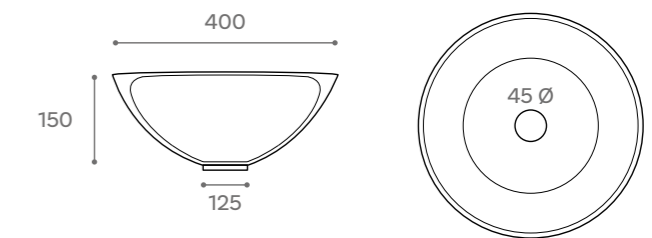

### CODING / CODIFICA

MODEL MODELLO	CODE CODICE	REFERENCE RIFERIMENTO
BOL BICOLOR	30.342.277	LAV.BOLS/RB

# OSIRIS BICOLOR

## DECORATIVE WASHBASINS



### FEATURES / CARATTERISTICHE

Countertop washbasin  
No overflow.  
2 color porcelain.

*Lavandino da appoggio.  
Senza sfioratore.  
Porcellana in 2 colori.*

 Bronze / black  
Bronzo / nero

### TECHNICAL INFORMATION / INFORMAZIONI TECNICHE

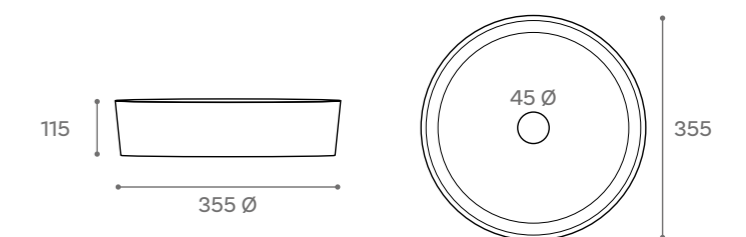

### CODING / CODIFICA

MODEL MODELLO	CODE CODICE	REFERENCE RIFERIMENTO
OSIRIS NEGRO BRONCE	30.417.277	LOBING35X35X12

# NALON

## DECORATIVE WASHBASINS



### FEATURES / CARATTERISTICHE

Countertop washbasin  
No overflow.  
Porcelain.

Lavandino da appoggio.  
Senza sfioratore.  
Porcellana.



### TECHNICAL INFORMATION / INFORMAZIONI TECNICHE

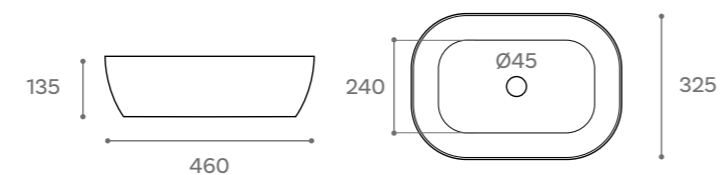

### CODING / CODIFICA

MODEL MODELLO	CODE CODICE	REFERENCE RIFERIMENTO
NALON BLACK-SILVER	30.342.277	LAV.NALON.NP
NALON BLACK-GOLD	30.342.277	LAV.NALON.NB
NALON BLACK	30.172.277	LAV.NALON

# BOL

## DECORATIVE WASHBASINS



### FEATURES / CARATTERISTICHE

Countertop washbasin  
No overflow.  
Porcelain.

Lavandino da appoggio.  
Senza sfioratore.  
Porcellana.



### TECHNICAL INFORMATION / INFORMAZIONI TECNICHE

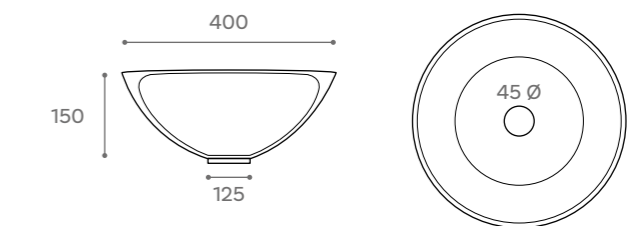

### CODING / CODIFICA

MODEL MODELLO	CODE CODICE	REFERENCE RIFERIMENTO
BOL GOLD	30.342.277	LAV.BOL.O
BOL SILVER	30.342.277	LAV.BOL.P
BOL BRONZE	30.342.277	LAV.BOL.B

# INDIANA

## DECORATIVE WASHBASINS



### FEATURES CARATTERISTICHE

Floor-standing washbasin.  
No overflow.  
Valve included.  
Stainless steel.

*Lavandino con colonna.  
Senza sfioratore.  
Con valvola inclusa.  
Acciaio inossidabile.*

### FINISHING FINITURA

 Stainless steel.  
Acciaio inox

 Matching valve  
Valvola abbinata

### TECHNICAL INFORMATION INFORMAZIONI TECNICHE

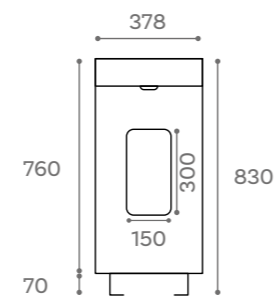
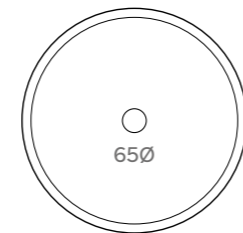

### CODING CODIFICA

MODEL MODELLO	CODE CODICE	REFERENCE RIFERIMENTO
INDIANA	30.1100.277	LAV.INDIANA

# ACRIS

## DECORATIVE WASHBASINS



### FEATURES / CARATTERISTICHE

Countertop washbasin  
No overflow.  
Valve included.  
Stainless steel.

*Lavandino da appoggio.  
Senza sfioratore.  
Con valvola inclusa.  
Acciaio inossidabile.*

 Stainless steel.  
Acciaio inox

 Matching valve  
Valvola abbinata

### TECHNICAL INFORMATION / INFORMAZIONI TECNICHE

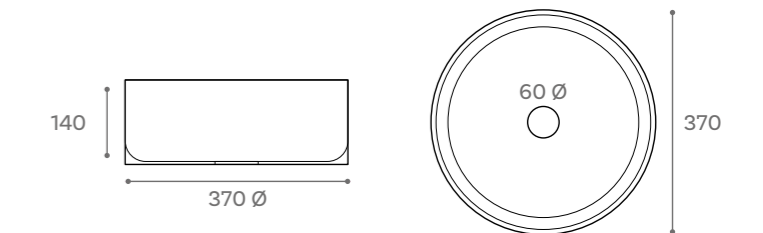

### CODING / CODIFICA

MODEL MODELLO	CODE CODICE	REFERENCE RIFERIMENTO
ACRIS	30.298.277	LAV.ACRIS

# CUBE

## DECORATIVE WASHBASINS



### FEATURES / CARATTERISTICHE

Countertop washbasin  
No overflow.  
Valve included.  
Stainless steel.

*Lavandino da appoggio.  
Senza sfioratore.  
Con valvola inclusa.  
Acciaio inossidabile.*

 Stainless steel.  
Acciaio inox

 Matching valve  
Valvola abbinata

### TECHNICAL INFORMATION / INFORMAZIONI TECNICHE

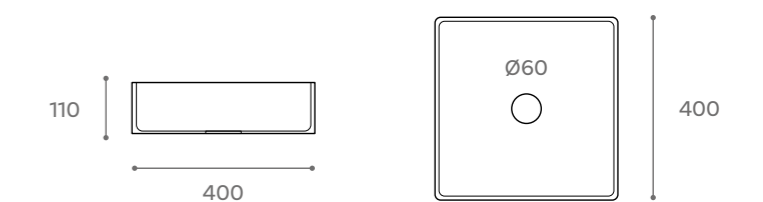

### CODING / CODIFICA

MODEL MODELLO	CODE CODICE	REFERENCE RIFERIMENTO
CUBE	30.298.277	LAV.CUBE



WASHBASINS

*LAVANDINI*

**GALLERIA SERIES**

## BACK TO ORIGINS

Handmade pottery has been produced for thousands of years. All known civilizations, and especially those closest to us, the Mediterranean ones, have used handmade pottery as a means of storage and decoration. Art&Bath pays tribute to these products that have accompanied us for centuries with its Galleria line. Craftsman know-how transferred to beautiful products made with time and dedication to achieve warm and timeless bathrooms.

## RITORNO ALLE ORIGINI

*La ceramica viene prodotta a mano da migliaia di anni. Tutte le civiltà conosciute, e soprattutto quelle più vicine a noi, quelle del Mediterraneo, hanno utilizzato la ceramica artigianale come mezzo di conservazione e decorazione. Art&Bath rende omaggio a questi prodotti che ci accompagnano da secoli con la sua linea Galleria. Il know-how artigianale, trasferito in splendidi prodotti realizzati con tempo e dedizione, consente di ottenere bagni accoglienti e atemporali.*



### FEATURES / CARATTERISTICHE

Countertop washbasin  
No overflow.  
Customized ceramics.

*Lavandino da appoggio.  
Senza sfioratore.  
Ceramica personalizzata.*

### TECHNICAL INFORMATION / INFORMAZIONI TECNICHE

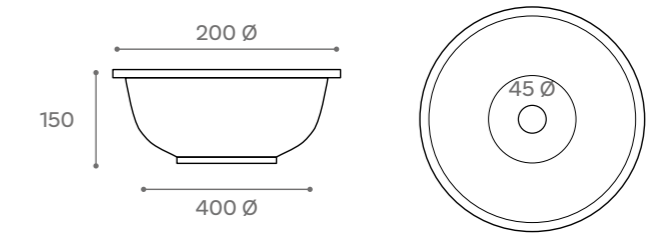

### FINISHING / FINITURA



White  
Bianco

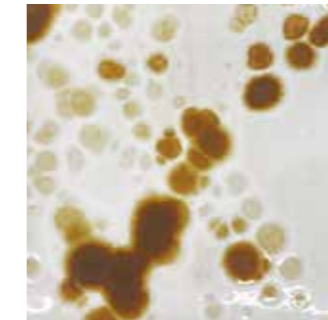

Splashes  
Schizzi



Mint  
Menta



Terracotta  
Terracotta

\*Finishes and shades of these articles may vary from one model to another as they are handcrafted products.  
\*Le finiture e le tonalità di questi articoli possono variare da un modello all'altro, poiché si tratta di prodotti artigianali.

### CODING / CODIFICA

MODEL MODELLO	CODE CODICE	REFERENCE RIFERIMENTO
ANCORA SPLASHES	30.525.277	LAV.ANCORASALP
ANCORA MINT	30.525.277	LAV.ANCORAMINT
ANCORA TERRACOTTA	30.525.277	LAV.ANCORATERR
ANCORA WHITE	30.525.277	LAV.ANCORABL



### FEATURES / CARATTERISTICHE

Countertop washbasin  
No overflow.  
Customized ceramics.

*Lavandino da appoggio.  
Senza sfioratore.  
Ceramica personalizzata.*

### TECHNICAL INFORMATION / INFORMAZIONI TECNICHE

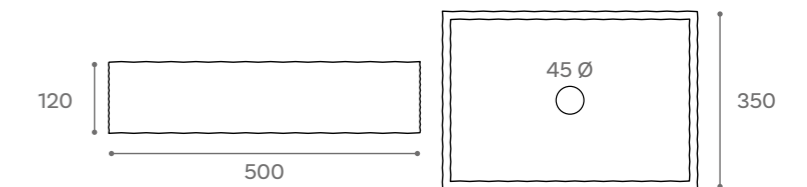

### FINISHING / FINITURA



White  
Bianco

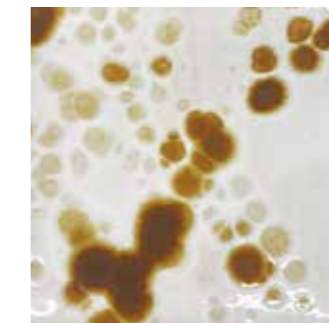

Splashes  
Schizzi



Mint  
Menta

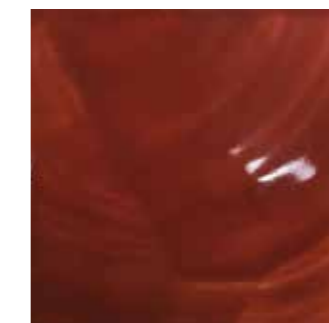

Terracotta  
Terracotta

\*Finishes and shades of these articles may vary from one model to another as they are handcrafted products.  
\*Le finiture e le tonalità di questi articoli possono variare da un modello all'altro, poiché si tratta di prodotti artigianali.

### CODING / CODIFICA

MODEL MODELLO	CODE CODICE	REFERENCE RIFERIMENTO
LAFONT TERRACOTTA	30.525.277	LAV.LAFONTTERR
LAFONT SPLASHES	30.525.277	LAV.LAFONTSALP
LAFONT MINT	30.525.277	LAV.LAFONTMINT
LAFONT WHITE	30.525.277	LAV.LAFONTBL



CABINET  
MOBILE LAVABO  
**BASIN**



### CODING / CODIFICA

#### ETNA MATTE WHITE AND BLACK/ ETNA BIANCO E NERO OPACO

DIMENSIONS MISURE	CODE CODICE	DIMENSIONS MISURE	CODE CODICE
61X46	30.126.277	61X39	30.138.277
71X46	30.164.277	71X39	30.165.277
81X46	30.164.277	81X39	30.165.277
91X46	30.196.277	-	-
101X46	30.206.277	-	-
121X46	30.295.277	-	-
DOUBLE SINK 121X46	30.310.277	-	-
DOUBLE SINK 141X46	30.560.277	-	-
LEFT SINK 101X46	30.265.277	-	-
LEFT SINK 121X46	30.335.277	-	-

# ETNA GLOSSY

## CABINET BASIN



Etna glossy white

### CODING / CODIFICA

#### ETNA GLOSSY WHITE / ETNA BIANCO LUCIDO

DIMENSIONS MISURE	CODE CODICE	DIMENSIONS MISURE	CODE CODICE
61X46	30.085.277	51X39	30.084.277
71X46	30.098.277	61X39	30.088.277
81X46	30.098.277	71X39	30.098.277
91X46	30.120.277	81X39	30.108.277
101X46	30.130.277	91X39	30.138.277
121X46	30.198.277	101X39	30.145.277
DOUBLE SINK 121X46	30.218.277	-	-
DOUBLE SINK 141X46	30.413.277	-	-
RIGHT AND LEFT SINK 81X46	30.125.277	-	-
RIGHT AND LEFT SINK 91X46	30.163.277	-	-
RIGHT AND LEFT SINK 101X46	30.175.277	-	-
RIGHT AND LEFT SINK 121X46	30.245.277	-	-
MODULAR LEFT SINK 121X46	30.255.277	-	-

# ETNA

## CABINET BASIN

### FEATURES / CARATTERISTICHE

Cabinet basin.  
With overflow.  
With faucet hole.  
Porcelain.

Mobile lavabo.  
Con sfioratore.  
Con foro per rubinetto.  
Porcellana.

### FINISHING / FINITURA



### TECHNICAL INFORMATION / INFORMAZIONI TECNICHE

#### CENTERED / CENTRATO

1 CENTERED SINK (Width 460mm)  
1 SENO CENTRATO (Larghezza 460 mm)

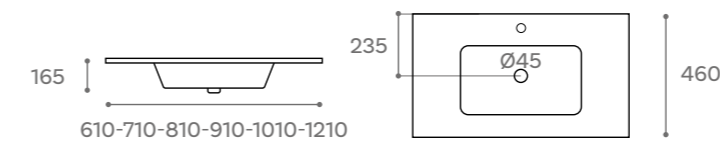

1 CENTERED SINK (Width 395mm)  
1 SENO CENTRATO (Larghezza 395 mm)

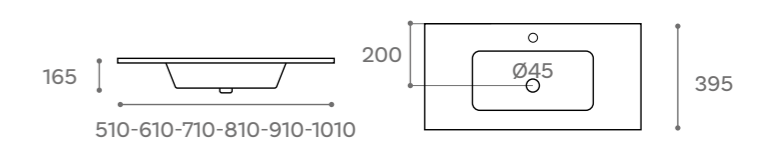

#### OFFSET / SPOSTATO

1 OFFSET SINK RIGHT AND LEFT  
1 SENO SPOSTATO A DESTRA E A SINISTRA

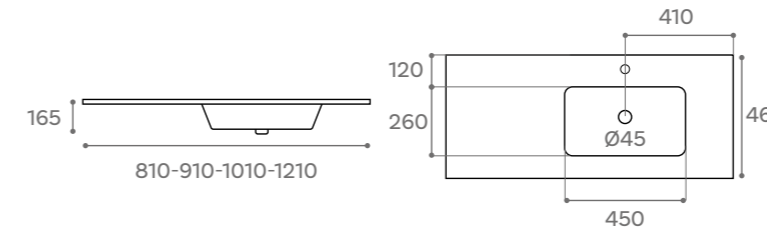

#### MODULAR / MODULARE

Dimensions valid for 2 modules of 60  
Misure valide per 2 moduli da 60

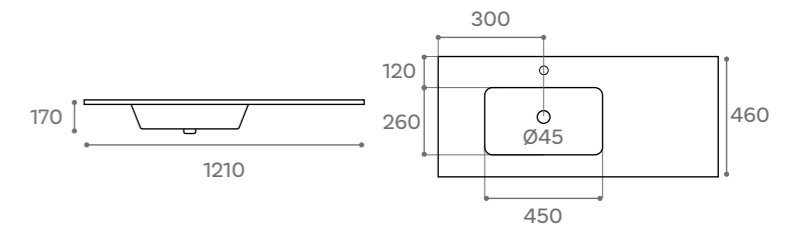

#### DOUBLE / DOPPIO

DOUBLE SINK (Width 460mm)  
DOPPIO SENO (Larghezza 460 mm)



# ETNA NERO

CABINET BASIN



## FEATURES / CARATTERISTICHE

Cabinet basin.  
With overflow.  
With faucet hole.  
Porcelain.

*Mobile lavabo.  
Con sfioratore.  
Con foro per rubinetto.  
Porcellana.*

## TECHNICAL INFORMATION / INFORMAZIONI TECNICHE

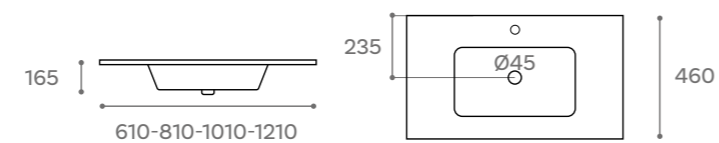

## FINISHING / FINITURA



Black marble  
Marmo nero

## CODING / CODIFICA

DIMENSIONS MISURE	CODE CODICE	REFERENCE RIFERIMENTO
61x46	30.160.277	ETNABL61
81x46	30.190.277	ETNABL81
101x46	30.240.277	ETNABL101
121x46	30.330.277	ETNABL121

# QUADRA

CABINET BASIN



## FEATURES / CARATTERISTICHE

Cabinet basin.  
With overflow.  
With faucet hole.  
Porcelain.

*Mobile lavabo.  
Con sfioratore.  
Con foro per rubinetto.  
Porcellana.*

## TECHNICAL INFORMATION / INFORMAZIONI TECNICHE

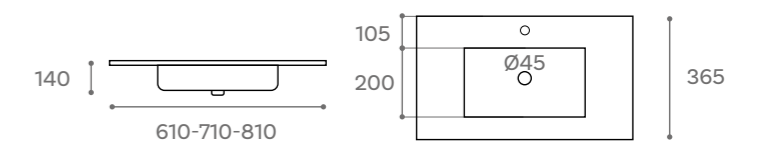

## FINISHING / FINITURA



Glossy white  
Bianco lucido

## CODING / CODIFICA

DIMENSIONS MISURE	CODE CODICE	REFERENCE RIFERIMENTO
61x36	30.77.277	ENQ61X36
71x36	30.91.277	ENQ71X36
81x36	30.98.277	ENQ81X36





### FEATURES / CARATTERISTICHE

Cabinet basin.  
With overflow.  
With faucet hole.  
Porcelain.

Mobile lavabo.  
Con sfioratore.  
Con foro per rubinetto.  
Porcellana.

### FINISHING / FINITURA

 Glossy white  
Bianco lucido

### TECHNICAL INFORMATION / INFORMAZIONI TECNICHE

#### CENTERED / CENTRATO

1 CENTERED SINK (Width 460mm)  
1 SENO CENTRATO (Larghezza 460 mm)

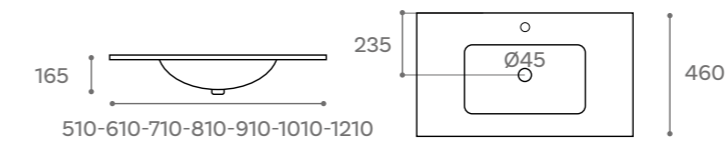

1 CENTERED SINK (Width 395mm)  
1 SENO CENTRATO (Larghezza 395 mm)

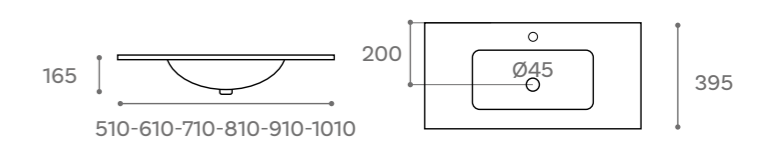

#### OFFSET / SPOSTATO

1 OFFSET SINK RIGHT  
1 SENO SPOSTATO DESTRA

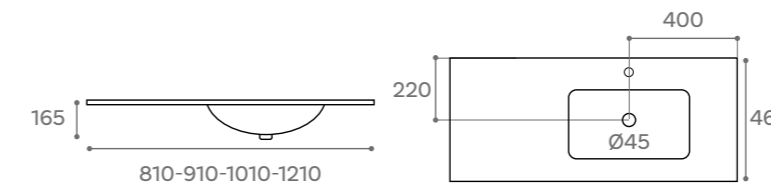

1 OFFSET SINK LEFT  
1 SENO SPOSTATO SINISTRA

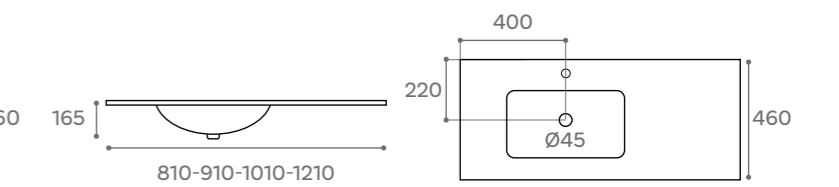

### CODING / CODIFICA

DIMENSIONS MISURE	CODE CODICE	DIMENSIONS MISURE	CODE CODICE
51X46	30.080.277	51X39	30.075.277
61X46	30.083.277	61X39	30.090.277
71X46	30.090.277	71X39	30.098.277
81X46	30.090.277	81X39	30.103.277
91X46	30.113.277	91X39	30.133.277
101X46	30.130.277	101X39	30.145.277
121X46	30.175.277	-	-
DOUBLE SINK 121X46	30.203.277	-	-
RIGHT AND LEFT SINK 81X46	30.120.277	-	-
RIGHT AND LEFT SINK 91X46	30.158.277	-	-
RIGHT AND LEFT SINK 101X46	30.190.277	-	-
RIGHT AND LEFT SINK 121X46	30.240.277	-	-

#### DOUBLE / DOPPIO

DOUBLE SINK (Width 460mm)  
DOPPIO SENO (Larghezza 460 mm)



CABINETS AND  
ACCESSORIES  
*MOBILI E ACCESSORI*

# SEVILLA

## CABINETS



### FEATURES / CARATTERISTICHE

Stainless steel cabinet.  
Delivered assembled.  
*Mobile di acciaio inossidabile.  
Viene fornito montato.*

Stainless steel.  
Acciaio inox

### CODING / CODIFICA

DIMENSIONS  
MISURE  
SEVILLA 100

CODE  
CODICE  
30.396.277

REFERENCE  
RIFERIMENTO  
MBSEV45X83X100

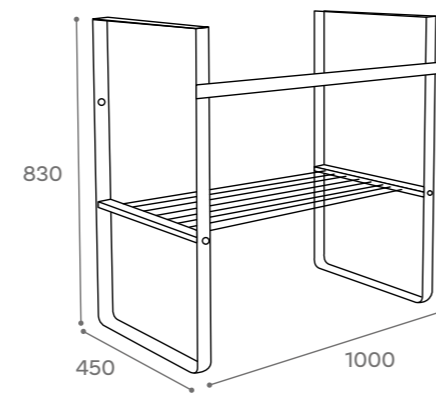

# HUESCA

## CABINETS



### FEATURES / CARATTERISTICHE

Stainless steel cabinet.  
Delivered assembled.  
*Mobile di acciaio inossidabile.  
Viene fornito montato.*

Stainless steel.  
Acciaio inox

### CODING / CODIFICA

DIMENSIONS  
MISURE  
HUESCA

CODE  
CODICE  
30.80.277

REFERENCE  
RIFERIMENTO  
ESTHUSCTO

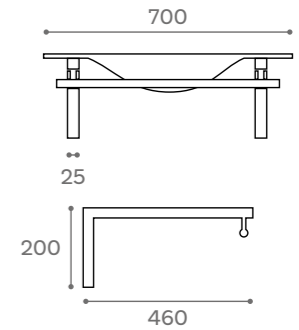

# TOLEDO

## CABINETS



### FEATURES / CARATTERISTICHE

Stainless steel cabinet.  
Delivered assembled.  
*Mobile di acciaio inossidabile.  
Viene fornito montato.*

Stainless steel.  
Acciaio inox

### CODING / CODIFICA

DIMENSIONS  
MISURE  
TOLEDO 80  
TOLEDO 100

CODE  
CODICE  
30.120.277  
30.148.277

REFERENCE  
RIFERIMENTO  
ESTTOLEDO80  
ESTTOLEDO100

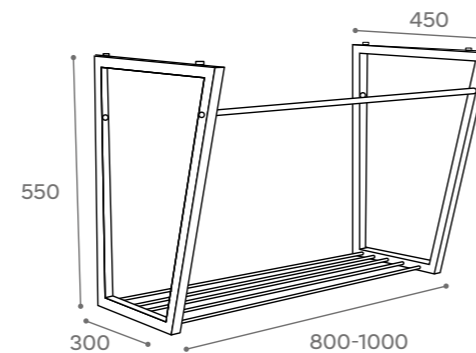

# SORIA

## CABINETS



### FEATURES / CARATTERISTICHE

Stainless steel cabinet.  
Delivered assembled.  
*Mobile di acciaio inossidabile.  
Viene fornito montato.*

Stainless steel.  
Acciaio inox

### CODING / CODIFICA

DIMENSIONS  
MISURE  
SORIA

CODE  
CODICE  
30.80.277

REFERENCE  
RIFERIMENTO  
ESTSORIA

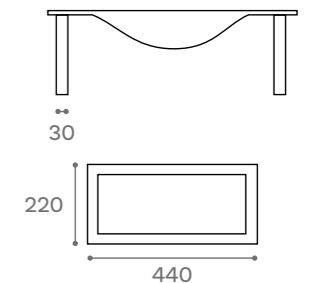

# LEG SET

## CABINETS

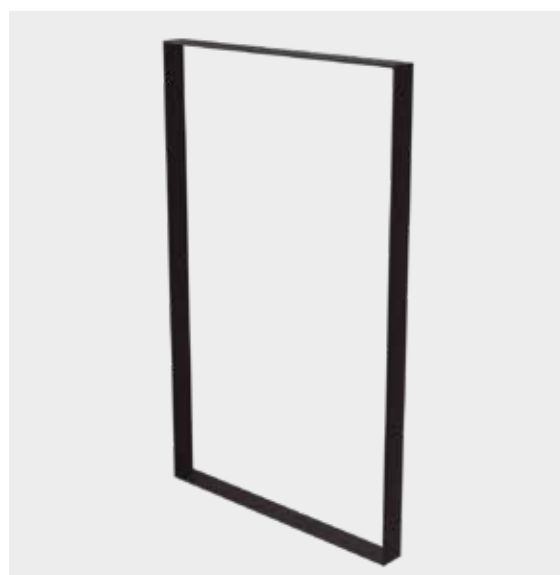

### FEATURES / CARATTERISTICHE

Leg set  
*Set di piedini*

Matte black  
Nero opaco

### CODING / CODIFICA

DIMENSIONS  
MISURE  
LEG SET

CODE  
CODICE  
30.98.277

REFERENCE  
RIFERIMENTO  
PIETABNEG

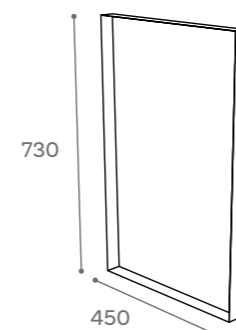

# ÁVILA

## CABINETS



### FEATURES / CARATTERISTICHE

Stainless steel cabinet.  
Delivered assembled.  
*Mobile di acciaio inossidabile.  
Viene fornito montato.*

### CODING / CODIFICA

DIMENSIONS  
MISURE  
ÁVILA 80  
ÁVILA 100

CODE  
CODICE  
30.75.277  
30.86.277

REFERENCE  
RIFERIMENTO  
ESTÁVILA80  
ESTÁVILA100

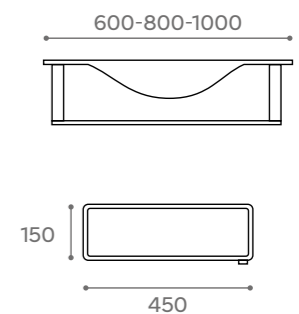

**"CLIC-CLAC" UNIVERSAL VALVE GLOSSY BLACK**



**FEATURES / CARATTERISTICHE**

Black gloss brass ceramic cover.  
Tappo in ceramica nero lucido ottone.

**CODING / CODIFICA**

MODEL MODELLO	CODE CODICE	REFERENCE RIFERIMENTO
CLIC-CLAC GLOSSY BLACK	30.20.277	VALUNI.L.NB

**"CLIC-CLAC" UNIVERSAL VALVE MATTE BLACK**



**FEATURES / CARATTERISTICHE**

Black matte brass ceramic cover.  
Tappo in ceramica nero in ottone.

**CODING / CODIFICA**

MODEL MODELLO	CODE CODICE	REFERENCE RIFERIMENTO
CLIC-CLAC MATTE BLACK	30.20.277	VALUNI.L.N

**"CLIC-CLAC" CERAMIC VALVE WHITE**



**FEATURES / CARATTERISTICHE**

White brass ceramic cover.  
Tappo in ceramica bianco in ottone cromato.

**CODING / CODIFICA**

MODEL MODELLO	CODE CODICE	REFERENCE RIFERIMENTO
CLIC-CLAC GLOSSY WHITE	30.19.277	VALUNI.L.P
CLIC-CLAC MATTE WHITE	30.19.277	VALUNI.TBM

**"CLIC-CLAC" UNIVERSAL VALVE MATTE WHITE**



**FEATURES / CARATTERISTICHE**

Matte white full brass.  
Blanc mate en laiton.

**CODING / CODIFICA**

MODEL MODELLO	CODE CODICE	REFERENCE RIFERIMENTO
CLIC-CLAC MATTE WHITE	30.24.277	VALUNI.BMC

**"CLIC-CLAC" UNIVERSAL VALVE MATTE BLACK**



**FEATURES / CARATTERISTICHE**

Matte black full brass.  
Tappo in ceramica nero in ottone.

**CODING / CODIFICA**

MODEL MODELLO	CODE CODICE	REFERENCE RIFERIMENTO
CLIC-CLAC MATTE BLACK	30.24.277	VALUNI.NMC

**"CLIC-CLAC" KRION® VALVE MATTE WHITE**



**FEATURES / CARATTERISTICHE**

Matte white cover.  
Bouchon en blanche mate.

**CODING / CODIFICA**

MODEL MODELLO	CODE CODICE	REFERENCE RIFERIMENTO
CLIC-CLAC KRION	30.55.277	VALUNI.TSI

**VALVE WITHOUT CLOSURE WITH COVER**



**FEATURES / CARATTERISTICHE**

Chrome brass.  
Cromato ottone.

**CODING / CODIFICA**

MODEL MODELLO	CODE CODICE	REFERENCE RIFERIMENTO
VALVE WITHOUT CLOSURE	30.16.277	VALUNI.ABI

**"CLIC-CLAC" UNIVERSAL VALVE**



**FEATURES / CARATTERISTICHE**

Chrome brass.  
Cromato ottone.

**CODING / CODIFICA**

MODEL MODELLO	CODE CODICE	REFERENCE RIFERIMENTO
CLIC-CLAC CHROME	30.17.277	VALUNI.L

**SQUARE FIXING**

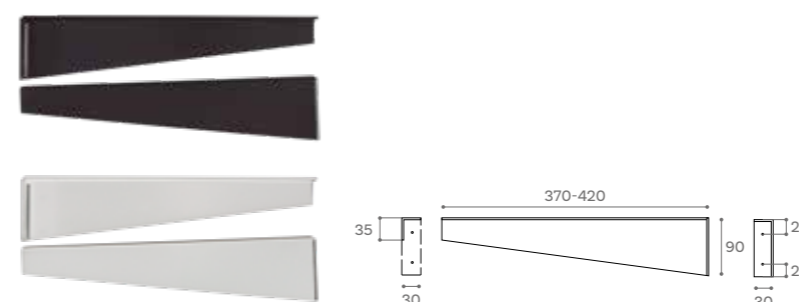

**FEATURES / CARATTERISTICHE**

Available in 37 and 42cm.  
Sold by unit.  
Available in matte white and black.

Disponibile en 37 et 42 cm.  
Si vende per unità.  
Disponibile in bianco e nero opaco.

**CODING / CODIFICA**

MODEL MODELLO	CODE CODICE	REFERENCE RIFERIMENTO
SQUARE FIXING	30.24.277	ESTESC

**FIXING SET**



**FEATURES / CARATTERISTICHE**

Fixing set.  
Kit di fissaggio.

**CODING / CODIFICA**

MODEL MODELLO	CODE CODICE	REFERENCE RIFERIMENTO
FIXING SET	30.14.277	TLI

## ROUND SIPHON



### FEATURES / CARATTERISTICHE

Round bottle siphon.  
*Sifone bottiglia rotondo.*

### CODING / CODIFICA

MODEL MODELLO	CODE CODICE	REFERENCE RIFERIMENTO
ROUND SIPHON	30.30.277	SIFON

## SQUARE SIPHON



### FEATURES / CARATTERISTICHE

Square bottle siphon.  
*Sifone bottiglia quadrato.*

### CODING / CODIFICA

MODEL MODELLO	CODE CODICE	REFERENCE RIFERIMENTO
SQUARE SIPHON	30.43.277	SIFONC

## MATTE WHITE SIPHON



### FEATURES / CARATTERISTICHE

Matte white round bottle siphon.  
*Sifone bottiglia rotondo bianco opaco.*

### CODING / CODIFICA

MODEL MODELLO	CODE CODICE	REFERENCE RIFERIMENTO
MATTE WHITE SIPHON	30.50.277	SIFONB

## MATTE BLACK SIPHON



### FEATURES / CARATTERISTICHE

Matte black round bottle siphon.  
*Sifone bottiglia rotondo nero opaco.*

### CODING / CODIFICA

MODEL MODELLO	CODE CODICE	REFERENCE RIFERIMENTO
MATTE BLACK SIPHON	30.50.277	SIFONN

## General Information

Innovación Baño, S.L. reserves the right to cancel and/or modify, totally or partially, any of the models, colors, formats, references and technical specifications contained in this catalog without any right to any damage. Pictures or infographics presented in the catalog may suffer a slight variation with respect to the real pieces.

## Terms and conditions of sale

The order shall be considered binding at the moment of its reception. Returns that have not been previously agreed by Innovación Baño, S.L. will not be admitted. The shipping costs of the returns due to cancellation of the order, or any reason not attributable to Innovación Baño, S.L. will be charged to the client. Once the goods and packaging are checked, if everything is in accordance, a minimum depreciation of 15% of the amount of the order will be applied.

It is necessary to review the goods at the time of reception. After 24 hours, no claim for breakage or defects caused by transport will be accepted. The claims for goods will be communicated by email to [comercial@artandbath.com](mailto:comercial@artandbath.com).

Shipping costs paid for orders over 350€ net for Peninsula. Orders under 350€ net will be charged 17€ for shipping to Peninsula. For shipments to the Balearic or Canary Islands, prior quotation is required.

The preparation time for orders with products in stock will be 48 hours, as long as the products are available. Products made to order, will have a service period of 15 working days.

## Warranty

The warranty will be 2 years on all products.

Our warranty covers the replacement of the material at no charge to the buyer, under the terms of current legislation.

Consequently, it only covers manufacturing defects, never operating or installation defects, independent of the former.

The warranty will be invalidated in the event of one or more of the following cases:

- Defects, damage caused in transport
- Damage caused by improper maintenance or the use of abrasive or unsuitable cleaning products.
- Products have been stored in the open air
- Products have been installed in a manner contrary to the specifications or regulations in force

## Informazioni generali

Innovación Baño, S.L. si riserva il diritto di cancellare e/o modificare, totalmente o parzialmente, qualsiasi modello, colore, formato, riferimento e specifica tecnica contenuta nel presente catalogo, senza che ciò dia diritto ad alcun tipo di risarcimento. Le fotografie o infografiche presentate nel catalogo possono subire una leggera variazione rispetto ai pezzi reali.

## Condizioni di vendita

L'ordine sarà considerato definitivo al momento in cui si riceve. Non si accetteranno resi che non siano stati precedentemente concordati da Innovación Baño, S.L. Le spese di spedizione dei resi dovuti all'annullamento dell'ordine o a qualsiasi altro motivo non imputabile a Innovación Baño, S.L. saranno a carico del cliente. Una volta che la merce è stata controllata e imballata, se tutto è in ordine, verrà applicato un ammortamento minimo del 15% sull'importo dell'ordine.

È necessario controllare la merce al momento del ricevimento della stessa; dopo 24 ore non saranno accettati reclami per rotture o difetti causati dal trasporto. I reclami sulla merce saranno comunicati via e-mail a [comercial@artandbath.com](mailto:comercial@artandbath.com).

Trasporto pagato per ordini superiori a 350€ netti per la Penisola.

Per gli ordini inferiori a 350€ netti verranno addebitati 17€ per le spese di spedizione nella Penisola. Per le consegne nelle Isole Baleari o Canarie è necessario richiedere un preventivo.

Il tempo di preparazione degli ordini con prodotti in stock sarà di 48 ore, a condizione che i prodotti siano disponibili. I prodotti fabbricati su ordinazione hanno un termine di servizio di 15 giorni lavorativi.

## Garanzia

La garanzia sarà di 2 anni su tutti i prodotti.

La nostra garanzia copre la sostituzione del materiale gratuitamente per l'acquirente, secondo i termini della legislazione vigente.

Di conseguenza, copre solo i difetti di fabbricazione, mai i difetti di funzionamento o di installazione, che sono indipendenti dai primi.

La garanzia decade nel caso in cui si verifichi uno o più dei seguenti casi:



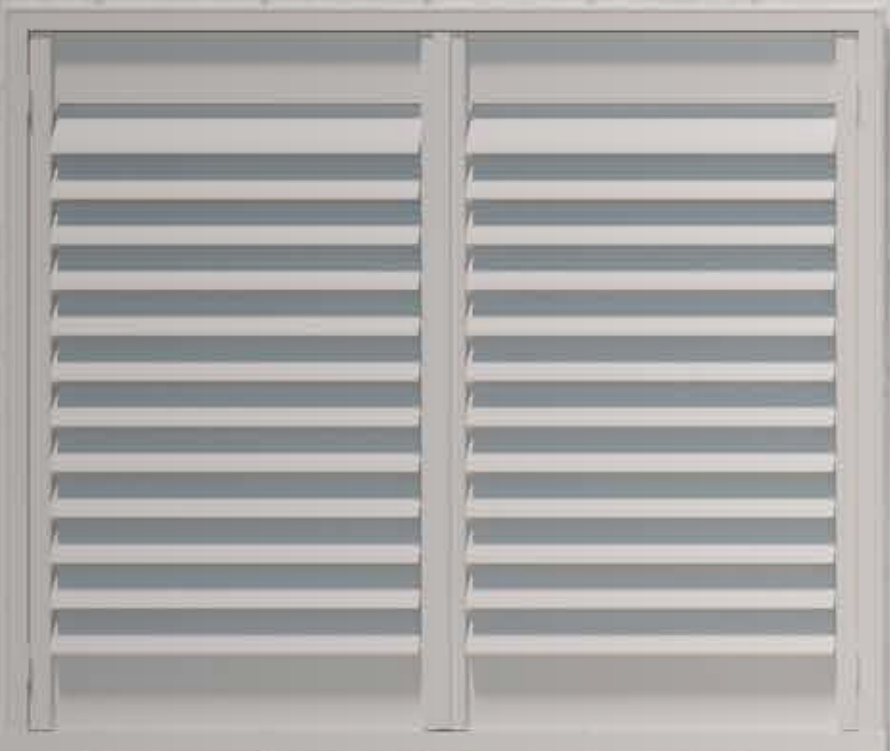

- Difetti, danni causati dal trasporto
- Danni causati da una manutenzione inadeguata o dall'uso di prodotti di pulizia abrasivi o inadeguati.
- I prodotti sono stati stoccati all'intemperie
- I prodotti sono installati in modo contrario alle specifiche o alle normative vigenti





**art&bath**

[www.artandbath.com](http://www.artandbath.com)  
Avinguda Mediterrani 102-104  
12200, Onda Castellón.  
[comercial@artandbath.com](mailto:comercial@artandbath.com)  
Tels. 964 626 007 / 964 626 007

-  @innovación-baño-sl
-  @artandbathes
-  @lavabosartandbath
-  @artandbathes